



# **Fuzzy Approach for Throughput Selection in Mobile Ad hoc Network**

Samiksha Nikam, B.T. Jadhav

Principal(o), Dept. of Computers, College of Computer Application for Women, Satara, S.N.D.T. Women's university,  
Mumbai, India

Associate Professor, Department of Electronics and Computer Sciences, Y.C. Institute of Sciences, Satara, Shivaji  
University, Kolhapur, India

**ABSTRACT:** Routing protocols are categorized as table driven and on demand protocol. In table driven protocol all possible routes are already stored in the routing table at each node. Proactive protocols generate route on demand. In both type of routing bandwidth available for communication is limited. It is challenging to maintain desired throughput due to dynamic nature, limited bandwidth, and interference during communication. Throughput of ad hoc network depends upon the parameters pause time of nodes, number of nodes, maximum speed and maximum connections of nodes of ad hoc network. We propose fuzzy logic to maintain desired throughput. Desired throughput is given as input to fuzzy inference system. The outcome of fuzzy system defines values for pause time, number of nodes, maximum speed and maximum connections. It helps to maintain desired throughput. Network simulator NS2.34 is used to perform simulations. Matlab is used to develop fuzzy inference system.

**KEYWORDS:** ad hoc network, routing protocol, throughput, fuzzy logic, network simulator, Matlab.

## **I. INTRODUCTION**

An ad hoc network is collection of nodes. It does not have any centralized control. In ad hoc network nodes can enter and leave a network as per their wish. Routes may break or new route forms during data communication process. Throughput is one of the important performance metric of ad hoc network. It decides capacity of network. It is difficult to achieve desired throughput due to mobility of nodes. Here we focus on throughput of ad hoc network for DSDV protocol. It is depend upon following ad hoc network parameters such as,

1. **Mobility of nodes** (Pause Time): When number of nodes, connections between the nodes and speed of nodes are constant then mobility of the nodes does not affect the throughput of the network
2. **Density of nodes** (Number of Nodes): Density of nodes has significant effect on throughput. Low density causes frequent connection failure and high density increases traffic in the network which decreases throughput. If the number of nodes in the network grows, the size of the routing tables and the bandwidth required to update them also grows
3. **Connection rate** (Maximum Speed of Nodes): Speed of node significantly affect throughput of network. As speed of node increases throughput is decreases. Due to increases in speed nodes enter and exit a network frequently. Because of this routes changes frequently this increases packet drop and reduces throughput.
4. **No. of connections** (Maximum Connection in between the Nodes): Throughput is highly depends on number of connections in between the nodes. As connections between the nodes increases updates packets are broadcasted throughout the network so every node in the network knows how to reach every other node. Thus increasing connections in between the nodes provides alternate route in case of route break. This increases throughput of network

It is challenging and complex job to maintain desired throughput for mobile ad hoc network. In such circumstances fuzzy logic is best suitable to take a decision. Hence we propose use of fuzzy logic to decide pause time, nodes, maximum speed and maximum connections to maintain desired throughput. Throughput can be express in linguistic terms like severely low, low, high, moderate desired etc.

# International Journal of Innovative Research in Computer and Communication Engineering

(An ISO 3297: 2007 Certified Organization)

Vol. 3, Issue 4, April 2015

## II. RELATED WORK

In [12] author proposes a fuzzy logic based decision system to select various parameters for ad hoc network. This facilitates the generation of effective results that shows the necessity for performing the appropriate model, in conjunction with this, MANET area research will be able to gain the advantages of the Fuzzy Inference system that provides some direction that how to target the challenges to achieve higher throughput at minimum cost and delay. By observing the model it can be found that which input parameters influences output parameters. In paper [17] author proposes improvement on AODV protocol by adding delay period of each path with number of hop count. Selection of route is based on fuzzy inference system.. It is observed that proposed protocol perform better than original protocol.

In research paper [6] researcher describes a semi-stateless approach based on a fuzzy logic system for wireless mobile ad hoc networks. The proposed model, called Fuzzy MARS assures service differentiation delivery with low delay transmission. The performance evaluation of the proposed model was studied under different mobility, channel, and traffic conditions. The results of simulations confirm that the proposed model can achieve a low and stable end-to-end delay under different network scalability and mobility conditions. Fuzzy logic techniques promise to be efficient tools for reducing delay transmission of multimedia applications in wireless ad hoc networks and deserve further attention and study. In [4] author proposes a fuzzy logic technique for gossip based reliable broadcasting in Mobile Ad hoc Networks. In this technique, each node computes the node velocity, residual energy and node degree. These inputs are passed through the fuzzy system and the fuzzyfied inputs are fed to the rule base system. The outcome of fuzzy system defines the value for retransmission probability.

## III. FUZZY SYSTEM

Network simulator is very useful tool for ad hoc network. It can be used to analyze performance of various protocol initially the parameters such as pause time (P.T.), nodes (N), maximum speed (M.S.), and maximum connections (M.C.) are set for ad hoc network and run the simulation. At the end of simulation NAM and Trace files are created. Nam file is a network animator which helps to visualize ad hoc network scenario. Trace file give statistical details about ad hoc network simulation. After simulation using trace file throughput is calculated by writing AWK script. If desired throughput is not get then change parameters such as P.T., N., M.S., and M.C. Again run the simulation and calculate throughput and repeat the process till desired throughput is achieved. This is a complex task hence fuzzy logic is proposed to reduce complexity of the process. Fuzzy systems are suitable for uncertain and approximate reasoning and help to take decision with estimated values under incomplete or uncertain information. [17]. Following flow chart make clear requisite of fuzzy system. If throughput is at desired level then maintain the parameters. Otherwise go to fuzzy inference system and change the parameters to obtain desired throughput. Here fuzzy logic is used to decide parameter values to get desired throughput.

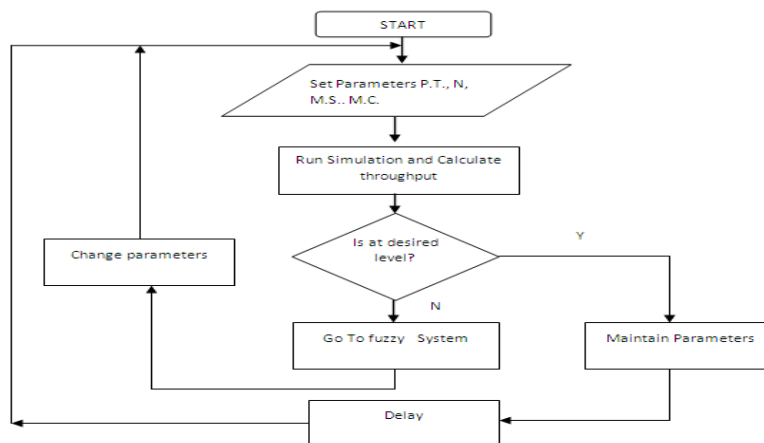

Fig 1.2 Flow Chart of Fuzzy System

# International Journal of Innovative Research in Computer and Communication Engineering

(An ISO 3297: 2007 Certified Organization)

Vol. 3, Issue 4, April 2015

## IV. DEVELOPMENT OF FUZZY SYSTEM

Following fig 1.3 shows block diagram of developed system. It consists of two modules i.e. fuzzy decision making system and network simulator. Throughput is given as input to fuzzy decision making system which gives output as pause time (P.T.), nodes (N), maximum speed of nodes (M.S.) and maximum connections (M.C.). Output values received from fuzzy decision making system are given to network simulator to maintain desired throughput.

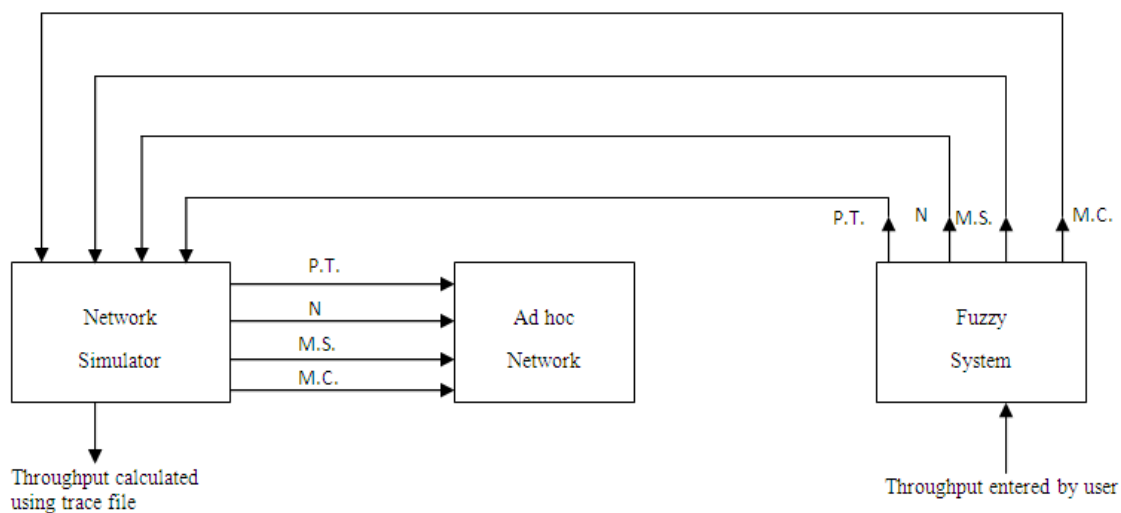

Fig 1.3 Block Diagram of Developed Fuzzy System

## V. FUZZY SYSTEM CONSTRUCTION

### A. Fuzzy System

A fuzzy system consist of three steps i.e. fuzzification, inference engine and defuzzification. Fuzzification is the process in which crisp values are transformed into membership values of fuzzy set. Fuzzified data is fed to inference engine. Inference engine calculate fuzzy output using rule base. Defuzzification is a mathematical process used to convert fuzzy output to crisp values. Fuzzy systems are able to make decisions in complex situation. Here fuzzy logic is used to decide parameters like pause time, nodes, speed and connections in such a way that it should maintain desired throughput. For development of fuzzy based system throughput is given as input to fuzzy inference system and output of system give four parameters i.e. P.T.,N, M.S. and M.C. Fuzzy inference system is constructed using Matlab . Following fig1.4 show input and output parameters selected to build fuzzy system. Triangular membership functions are used to design fuzzy sets. Figure 1.5 shows triangular membership function for input parameter throughput.

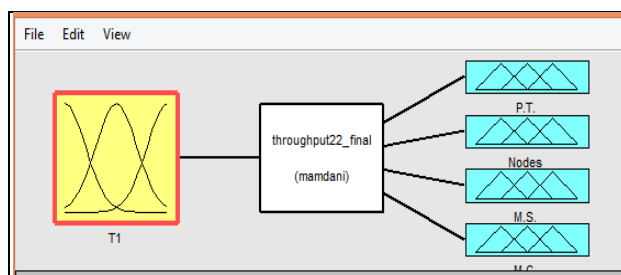

Fig 1.4 Input and Output Parameters of Fuzzy System

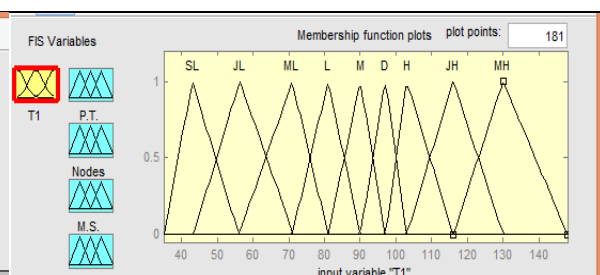

Fig 1.5 Membership Functions of Throughput (T1)

Following figure 1.6 to fig 1.9 shows membership function for output parameters i.e Pause time, Nodes, Max. speed and Max. connections respectively. Total nine triangular fuzzy sets are designed for each parameter.

# International Journal of Innovative Research in Computer and Communication Engineering

(An ISO 3297: 2007 Certified Organization)

Vol. 3, Issue 4, April 2015

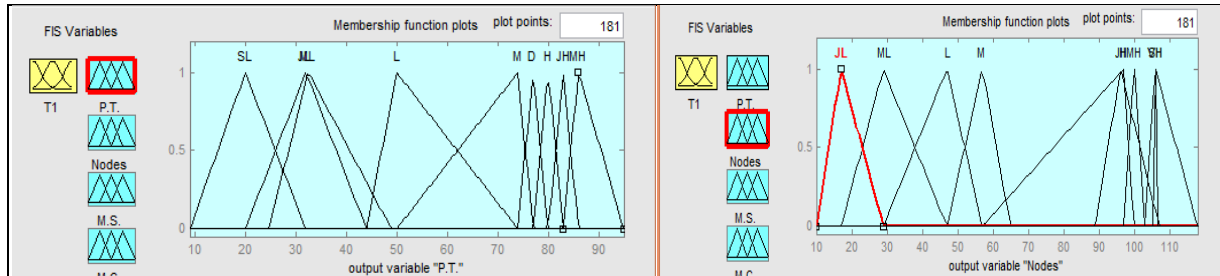

Fig 1.6 Membership Functions of Pause Time (P.T.)

Fig 1.7 Membership Functions of Nodes (N)

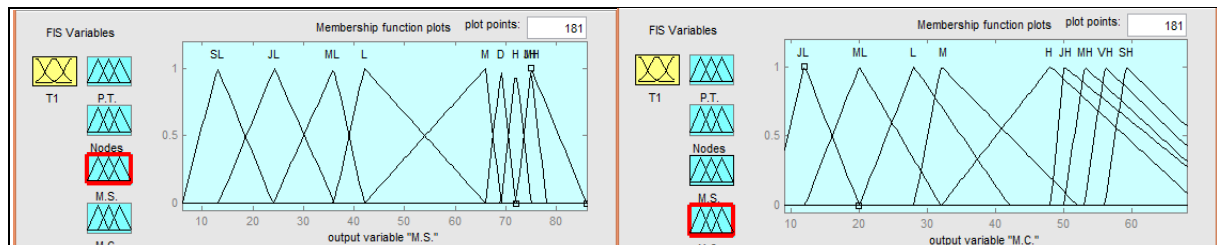

Fig 1.8 Membership Functions of Max. Speed (M.S.)

Fig 1.9 Membership Functions of Max. Connections (M.C.)

Table 1.1 shows minimum and maximum ranges for fuzzy input and output parameters.

Table 1.1 fuzzy ranges for Input and Output Parameters

Fuzzy parameters	Min	Max
Throughput(Kbps)	35	148
Pause time(ms)	9	95
Nodes	10	118
Max. speed(ms)	6	86
Max. Connections	7	68

Total nine fuzzy sets are designed for input and output parameters as shown in Table 1.2 and 1.3.

Table 1.2 Fuzzy Sets for Input Parameter

Fuzzy sets	Throughput
Severely Low (SL)	L (35,35, 56)
Just Low (JL)	^(43,56,71)
Moderate Low (ML)	^ (56,71,84)
Low (L)	^ (71,84,90)
Moderate (M)	^ (84,90,97)
Desired (D)	^ (90,97,103)
High (H)	^ (97,103,116)
just High (JH)	^ (103,116,130)
Moderate High (MH)	┘ (116,148,148)

# International Journal of Innovative Research in Computer and Communication Engineering

(An ISO 3297: 2007 Certified Organization)

Vol. 3, Issue 4, April 2015

Table 1.3 Fuzzy Sets for Output Parameters

Fuzzy sets	Max. connections	nodes	Fuzzy sets	Max. Speed(M.S.)	Pause time(P.T.)
Just Low (JL)	L (7,12,12)	L (10,17,17)	Severely Low (SL)	L (6,13,24)	L (9,9,32)
Moderate Low (ML)	^ (12,20,28)	^ (17,29,47)	Just Low (JL)	^ (13,24,36)	^ (20,32,44)
Low (L)	^ (20,28,30)	^ (29,47,52)	Moderate Low (ML)	^ (24,36,39)	^ (32,44,56)
Moderate (M)	^ (28,30,48)	^ (47,52,97)	Low (L)	^ (36,48,66)	^ (44,56,74)
High (H)	^ (32,48,50)	^ (57,97,100)	Moderate (M)	^ (48,66,69)	^ (56,74,77)
just High (JH)	^ (48,50,53)	^ (97,100,103)	Desired (D)	^ (66,69,72)	^ (74,77,80)
M oderate High (MH)	^ (50,53,56)	^ (100,103,106)	High (H)	^ (69,72,75)	^ (77,80,83)
Very High (VH)	^ (53,56,59)	^ (103,106,106)	just High (JH)	^ (72,75,78)	^ (80,83,86)
Severely High (SH)	┘ (56,68,68)	┘ (106,118,118)	Moderate High (MH)	┘ (75,78,86)	┘ ( 83,86,95)

Fuzzy rule base suggested by researcher is given in Table 1.4 fuzzy rules are generated in IF –THEN format.

Table 1.4 Fuzzy Rule Base

<b>IF</b>	<b>Throughput is</b>	<b>THEN</b>	<b>P.T.</b>	<b>AND</b>	<b>N</b>	<b>AND</b>	<b>M.S.</b>	<b>AND</b>	<b>M.C.</b>
	SL		SL		JL		SL		JL
	JL		JL		ML		JL		ML
	ML		ML		L		ML		L
	L		L		M		L		M
	M		M		H		M		H
	D		D		JH		D		JH
	H		H		MH		H		MH
	JH		JH		VH		JH		VH
	MH		MH		SH		MH		SH

Fig 1.9 shows output values for throughput set at 103 kbps

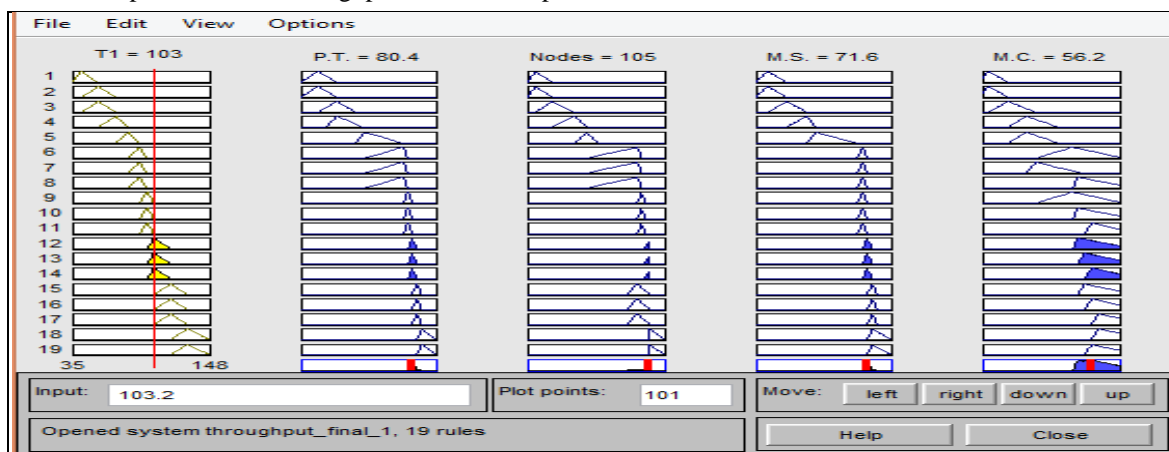

Fig 1.9 Ouput of fuzzy system for Throughput = 103 kbps

## VI. SIMULATION RESULT

Desired throughput is given as input to Fuzzy inference system which maps values for P.T., N., M.S., and M.C.. These parameters set for ad hoc network and simulation is run. At the end of simulation throughput is calculated.



# International Journal of Innovative Research in Computer and Communication Engineering

(An ISO 3297: 2007 Certified Organization)

Vol. 3, Issue 4, April 2015

Throughput values are compared to check accuracy of the result. Network simulator ns2.34 is used. Following steps are used to carry out simulation.

### Step1. Setting up the user parameters

Fuzzy inference system gives values of the parameters (P.T. , N, M.S. and M.C.) to get desired throughput. These parameters are set for ad hoc network using scenario and traffic files.

### Step 2. Set up the simulation parameters

Following simulation parameters are set to carry out simulations

Table 1.5 Simulation Parameters

Parameter	Value
Ad-hoc Routing Protocol	DSDV
Antenna Type	Omni directional
Simulation Time	100 ms
Simulation Area	500 X 500
Traffic Type	CBR
Node Speed	6 - 86 m/s
Data Packets	512bytes
Pause Time	0 -100 s in steps of 10
Number of Nodes	10 - 118
Mobility Model	Random Waypoint
Propagation Model	Two-ray Ground reflection
Interface Queue Type	Drop Tail/ Priority Queue
Interface Queue Length	50 Packets
Max. Number of Connections	7 - 70

**Step3. TCL Script:** After generation of scenario and traffic pattern TCL script is written for generation of trace file.

**Step4. AWK Script:** Trace files (.tr) analysed using awk script. Awk scripts are written to evaluate performance parameters of ad hoc network.

**Step5.** After analysis of trace files results are stored in text file or excel file and graph can be drawn using built in utility [3].Following data base shown in table 1.6 is created using fuzzy inference system. Desired throughput is fed to fuzzy inference system which gives values for four output parameters. These parameters are set for ad hoc network using network simulator. Then simulation is carried out and throughput is again measured to check accuracy of fuzzy inference system.

Table 1.6 Database created using fuzzy inference system

Sr no	Input to Fuzzy system	Output from Fuzzy System			
	Throughput	P.T.	Nodes	M.S.	M.C
1.	38.69	20.2	17	14.8	14
2	40.73	20.2	17	14	13
3	42.96	20.2	17	14	13
4	43.44	20.2	17	14	13
5	49.75	26.2	27	20.4	19
6	51.56	26.2	27	20.4	18
7	51.46	26.2	27	20.4	18
8	56.68	27.1	27	21.2	19
9	58.23	27.1	28	21.2	20
10	66.07	31.4	39	28.4	27
11	68.77	33.1	42	32.4	29
12	71.33	35.7	45	34.8	30
13	84.54	58.9	74	50	42



## International Journal of Innovative Research in Computer and Communication Engineering

(An ISO 3297: 2007 Certified Organization)

Vol. 3, Issue 4, April 2015

14	81.03	55.4	56	46.8	30
15	81.86	55.4	59	47.6	31
16	84.74	58.9	74	50	43
17	87.09	64.9	81	54	46
18	89.15	67.5	86	66.8	48
19	89.63	67.5	86	68.4	48
20	89.52	67.5	86	68.4	48
21	89.48	67.5	86	68.4	48
22	90.94	68.3	87	69.2	48
23	97.22	76.9	100	69.2	52
24	103.76	80.4	104	72.4	57

Table 1.7 shows result for throughput values. First column shows throughput values fed to fuzzy system and second column shows throughput calculated after setting parameter values for network simulator using fuzzy system. By comparing both the columns we observed that throughput can be set at approximate desired values using fuzzy system.

Table 1.7 Throughput Comparisons

Sr no	Throughput Inputted to FIS	Throughput calculated using network simulator
1.	38.69	45.87
2	40.73	45.87
3	42.96	45.87
4	43.44	45.87
5	49.75	49.96
6	51.56	49.96
7	51.46	49.96
8	56.68	54.75
9	58.23	54.75
10	66.07	65.63
11	68.77	68.46
12	71.33	77.92
13	84.54	86.70
14	81.03	83.95
15	81.86	82.35
16	84.74	88.62
17	87.09	90.29
18	89.15	90.67
19	89.63	90.67
20	89.52	90.67
21	89.48	90.67
22	90.94	91.90
23	97.22	99.48
24	103.76	123.20

Following figure 1.10 shows graphical representation of throughput comparison. It is observed that throughput is maintained at desired level using fuzzy inference system.



# International Journal of Innovative Research in Computer and Communication Engineering

(An ISO 3297: 2007 Certified Organization)

Vol. 3, Issue 4, April 2015

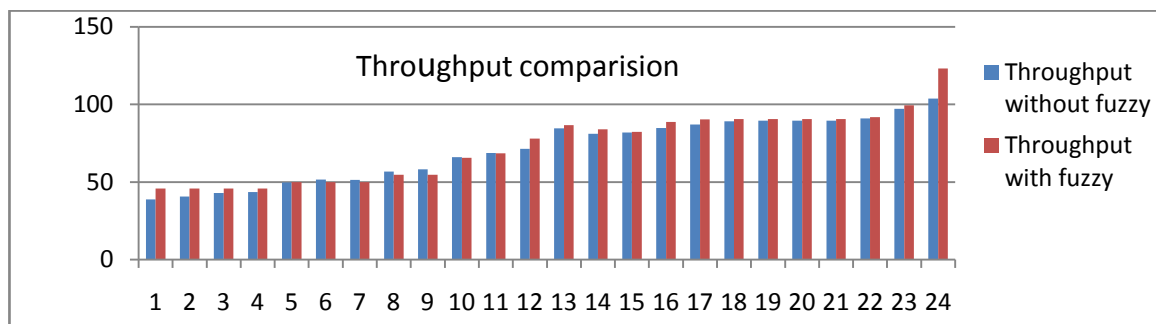

Fig. 1.10 Throughput Comparison

## VII. CONCLUSION

This paper proposes a fuzzy logic based decision system to decide throughput for ad hoc network. Due to dynamic nature of ad hoc network it is difficult to maintain desired throughput. To maintain required throughput error and trials have to be carried out. Practically it is not feasible. Hence we proposed fuzzy inference system which helps to maintain desired throughput for ad hoc network. Fuzzy inference system gives parameter values for Pause time, Nodes, Max. speed and Max. connections to maintain desired throughput.

## REFERENCES

1. Ahmed A. Radwan, Tarek M. Mahmoud and Essam H. Houssein, "Performance Measurement of Some Mobile Ad Hoc Network Routing Protocols", IJCSI International Journal of Computer Science Issues, Vol. 8, Issue 1, January 2011 ISSN (Online): 1694-0814
2. C.Siva Ram Murthy, B.S.Manoj, "Ad Hoc Wireless Networks", PEARSON, ISBN 978-81-317-0688-6, Twenty Second Impression.
3. G.Jose, Moses, D.Sunil Kumar, Prof.P.Suresh Varma, N.Supriya, "A Simulation Based Study of AODV, DSR, DSDV Routing Protocols in MANET Using NS-2", International Journal of Advanced Research in Computer Science and Software Engineering, ISSN: 2277 128X, Volume 2, Issue 3, March 2012.
4. G.Kalpna, Dr.M.Punithavalli, "Fuzzy Logic Technique For Gossip Based Reliable Broadcasting In Mobile Ad Hoc Networks", Journal of Theoretical and Applied Information Technology 31 st May 2013. Vol. 51 No.3, ISSN :1992-8645.
5. Guoyou He, "Destination-Sequenced Distance Vector (DSDV) Protocol"
6. Lyes Khoukhi and Soumaya Cherkaoui, "Experimenting with Fuzzy Logic for QoS Management in Mobile Ad Hoc Network Lyes Khoukhi" IJCSNS International Journal of Computer Science and Network Security, VOL.8 No.8, August 2008.
7. Madhuri Pal, Kalyani Satone, Bhawa Chilke "Implementation DSDV routing protocol for wireless mobile ad-hoc network, using NS2 simulator"
8. International Journal of Engineering Research & Technology (IJERT) Vol -. 1 Issue 8, October - 2012 ISSN: 2278-0181
9. Md. Anisur Rahman, Md. Shohidul Islam, Alex Talevski, "Performance Measurement of Various Routing Protocols in Ad-hoc Network", Proceedings of the International MultiConference of Engineers and Computer Scientists 2009 Vol I IMECS 2009, March 18 - 20, 2009, ISBN: 978-988-17012-2-0
10. Mehran Abolhasan a, Tadeusz Wysocki a, Eryk Dutkiewicz, "review of routing protocols for mobile ad hoc networks". Ad Hoc Networks 2 ,pp1-22,2004.
11. Mueen Uddin, Azizah Abdul Rahman, Abdulrahman Alarifi Muhammad Talha, Asadullah Shah, Mohsin Iftikha and Albert Zomay, "Improving Performance Of Mobile Ad Hoc Networks Using Efficient Tactical On Demand Distance Vector (Taodv) Routing Algorithm", International Journal of Innovative Computing, Information and Control ICIC International c 2012 ISSN 1349 4198 Volume 8, Number 6, June 2012 pp. 4375-4389
12. Nurul I. Sarkar, syafnidar A. Halim, "A Review of Simulation of Telecommunication Networks: Simulators, Classification, Comparison, Methodologies, and Recommendations", Cyber Journals: Multidisciplinary Journals in Science and Technology, Journal of Selected Areas in Telecommunications (JSAT), March Edition, 2011.
13. Pankaj Sharma, Shruti Kohli, Ashok Kumar Sinha, "DSR Routing Decisions for Mobile Ad Hoc Networks using Fuzzy Inference System Sundarapandian et al. (Eds): CoNeCo, WiMo, NLP, CRYPSIS, ICAIT, ICDIP, ITCSE, CS & IT 07, pp. 31-36, © CS & IT-CSCP 2012
14. S. Mohapatra, P.Kanungo, "Performance analysis of AODV, DSR, OLSR and DSDV Routing Protocols using NS2 Simulator", International Conference on Communication Technology and System Design 2011, Available online at [www.sciencedirect.com](http://www.sciencedirect.com)
15. Sampo Naski, "Performance of Ad Hoc Routing Protocols: Characteristics and Comparison", HUT T-110.551 Seminar on Internetworking, 2004.
16. Subir Kumar Sarkar, T.G. Basavraj, C. Puttamadappa, "AdHoc Mobile Wireless Network, Auerbach Publication.
17. S.Y. Wang, C.L. Chou, C.H. Huang, C.C. Hwang, Z.M. Yang, C.C. Chiou, and C.C. Lin, "The Design and Implementation of the NCTUns 1.0 Network Simulator".
18. Taqwa Odey Fahad, Prof. Abduladhim A. Ali, "Improvement of AODV Routing on MANET using Fuzzy System" Iraq J. Electrical and Electronic Engineering, Vol. 7, No 2, 2011.