



High-Gain Low-Noise Pre-Amplifier and Narrow Band-Pass Filter for Photoacoustic Spectrometer

*Sapna¹, P. Bhaskar², Parvathi C. S³., Immanuel J⁴

Research Scholar, Dept. of Instrumentation Technology, Gulbarga University, P.G. Centre, Raichur, KA, India¹

Professor, Dept. of Instrumentation Technology, Gulbarga University, P.G. Centre, Raichur, KA, India²

Professor, Dept. of Instrumentation Technology, Gulbarga University, P.G. Centre, Raichur, KA, India³

Guest Lecturer, Dept. of Instrumentation Technology, Gulbarga University, P.G. Centre, Raichur, KA, India⁴

ABSTRACT: In this paper an attempt is made to design and develop a high-gain low-noise pre-amplifier and a narrow band-pass filter for photoacoustic spectrometer (PAS). A two-stage pre-amplifier with the gain of 1000 and a second order state variable narrow band-pass filter are designed and fabricated. The pre-amplifier and narrow band-pass filter circuits are designed with a low-noise op-amp (LM308). This arrangement improves the sensitivity and signal-to-noise ratio of the photoacoustic (PA) signal. The frequency response of the PA cell is studied with carbon-black and liquid crystal samples. The resonant frequency of the PA cell was found at 345Hz. The performance of the system is tested in both the presence and absence of modulated laser beam applied on the sample, and it is found that the signal quality has been improved with the pre-amplifier and narrow band-pass filter designed for the present study.

KEYWORDS: Pre-amplifier, Narrow band-pass filter, Photoacoustic, Spectrometer, low-noise.

I. INTRODUCTION

Modern measurement systems are the fruits of science and technology. The precise measurement systems play an important role in science and technology. No doubt several investigators have designed various pre-amplifiers and narrow band-pass filters through variety of techniques. The signal-to-noise ratio is the most important parameter that needs to be considered, when low level measurements or high resolution measurements are attempted [1-2]. A pre-amplifier conditions the signal coming from a transducer/detector for further amplification. Its primary function is to extract the signal from the detector without disturbing the intrinsic signal-to-noise ratio [3]. High-gain pre-amplifiers are commercially available, and can also be built using discrete components like FETs/MOSFETs and low noise integrated circuits like LM308, OP07 etc.

It has to be noted that, even with the best available electronic circuitry, the amplifier noise exceeds the signal generated by the transducer itself [4] resulting in a detection sensitivity far below the theoretical limits determined by the displacement of the microphone diaphragm [5]. Several circuits for microphone and piezoelectric transducer pre-amplifiers have been described by several investigators [6-8]. The use of operational amplifiers with low temperature coefficient and large feedback substantially reduces the gain drift with temperature in comparison to pre-amplifiers with FETs/MOSFETs in the input stage. There are electret microphones with built in MOSFET amplifiers which makes it easy to couple them to moderately high input impedance pre-amplifiers. The output of the pre-amplifier is normally applied to the narrow band-pass filter to improve the signal quality.

Filters can be broadly classified into two types viz., passive filters and active filters. One of the serious constraints with the passive filters is the necessity to always use the specified source and termination impedances, besides compensating for the heavy attenuation suffered by the signal. Cascading of the filters is also not a straight forward solution in spite of designing the filters so that their source and termination impedances are equal. Additional isolation amplifiers are to be interposed between cascaded filter sections. This introduces severe distortion in the filter characteristics due to non-ideal matching between source-end and the input filter-end section and the output-end of the filter and the input



International Journal of Advanced Research in Electrical, Electronics and Instrumentation Engineering

(An ISO 3297: 2007 Certified Organization)

Vol. 3, Issue 11, November 2014

amplifier section or the filter-end section terminating load [9-11]. Another main drawback is the necessity to use bulky and often non-linear inductors for low and very low frequency filters.

The availability of operational amplifiers in the integrated circuit form has tremendously changed the concept of filter design, leading to the emergence of active filters. Today, a majority of low frequency filters are necessarily of this type, particularly for frequencies below 100 kHz. The special advantage of the active circuitry for use as low frequency filters is the fact that inductors can be totally avoided. However, due to the limited gain bandwidth product of IC and their effect on the filter characteristics, these filters are limited to few hundred kilohertz. The recently introduced inexpensive general purpose FET input operational amplifiers are particularly useful in the design of active filters [12-13].

PAS is one of the best and most reliable scientific/analytical instruments for phase transition studies and for the study of thermodynamical aspects of different samples [14-15]. This instrument uses PA cell for placing the samples under investigation. The output of PA cell is an acoustic signal with very low amplitude and buried in noise. This acoustic signal needs to be amplified and filtered for further analysis. In order to do this, we need a high-gain low-noise pre-amplifier and narrow band-pass filter. Hence in the present work a high-gain low-noise pre-amplifier and narrow band-pass filter with improved signal-to-noise ratio are designed and fabricated for photoacoustic spectrometer applications.

Literature survey:

From the literature survey it is found that, several authors proposed various designs for building pre-amplifiers and narrow band-pass filters, which have their own advantages and disadvantages. Kurihara, Y., *et al.*, designed a DC coupled single input pre-amplifier with wider low-frequency and rail-to-rail transconductance amplifier for capacitive sensors such as capacitive electret film type sensor [16]. Jawed S.A. *et al.*, designed a multi-function two stage chopper-stabilized pre-amplifier for MEMS capacitive microphone. The gain and high-pass filtering corner can be adjusted by digitally controlling the capacitor banks in the pre-amplifier [17]. Rieger.R. *et al.*, designed a low-noise pre-amplifier for nerve cuff electrode recording where certain important issues involved in the designing of nerve signal pre-amplifier for implantable neuroprotheses were discussed and design and evaluation of a complete pre-amplifier fabricated in a 0.8- μm double-metal double-poly process were described [18]. Hunter I.C. *et al.*, presented explicit design formulas for electronically tunable microwave band-pass filters and the computer analysis of varactor tuned combine band-pass filter including the small signal varactor equivalent circuit which enables filter performance to be easily evaluated [19]. Matthei G.I showed the important advantages for designing compact narrow-band filters by introducing hairpin-comb filter which have special properties that are advantageous for the design of compact, narrow-band, and bandpass microstrip filters [20].

II. METHODOLOGY OF THE SYSTEM

The complete schematic of the system is shown in Fig.1. The carbon soot quoted on glass plate of 1.0 cm diameter, acts as a sample, is placed in the sample cavity of the PA cell as shown in Fig.2. The PA cell is designed according to Helmholtz resonance principle [21-22]. A switchable diode laser which has 808nm of wave length and 50mW of optical power is used as radiation source. The laser beam is modulated by connecting the diode laser to the collector of the transistor (CL 100) and modulating signal (TTL square wave) to base of the transistor. When the modulated laser beam falls on the surface of the carbon black, produces an acoustic signal of same frequency as that of the modulating signal. This acoustic signal is converted into electrical signal by an electret microphone (KECG3644PFG, of KSA Electronics make) which can be operated with supply voltage ranging from 3 to 10V and has an output impedance of about 2.2k Ω and sensitivity of about 44 \pm 3dB [22]. The typical noise level of the microphone is \sim 4nV/ $\sqrt{\text{Hz}}$. When the PA signal is amplified, the microphone noise would also amplify along with the PA signal. Hence, a compromise between the signal-to-noise ratio (SNR) and the amplifier gain is necessary for optimum PA signal detection.

International Journal of Advanced Research in Electrical, Electronics and Instrumentation Engineering

(An ISO 3297: 2007 Certified Organization)

Vol. 3, Issue 11, November 2014

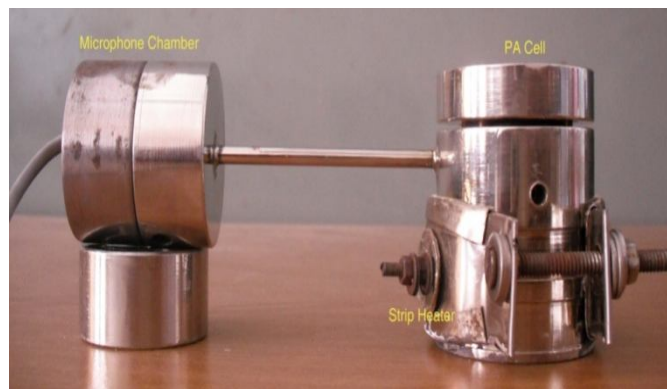
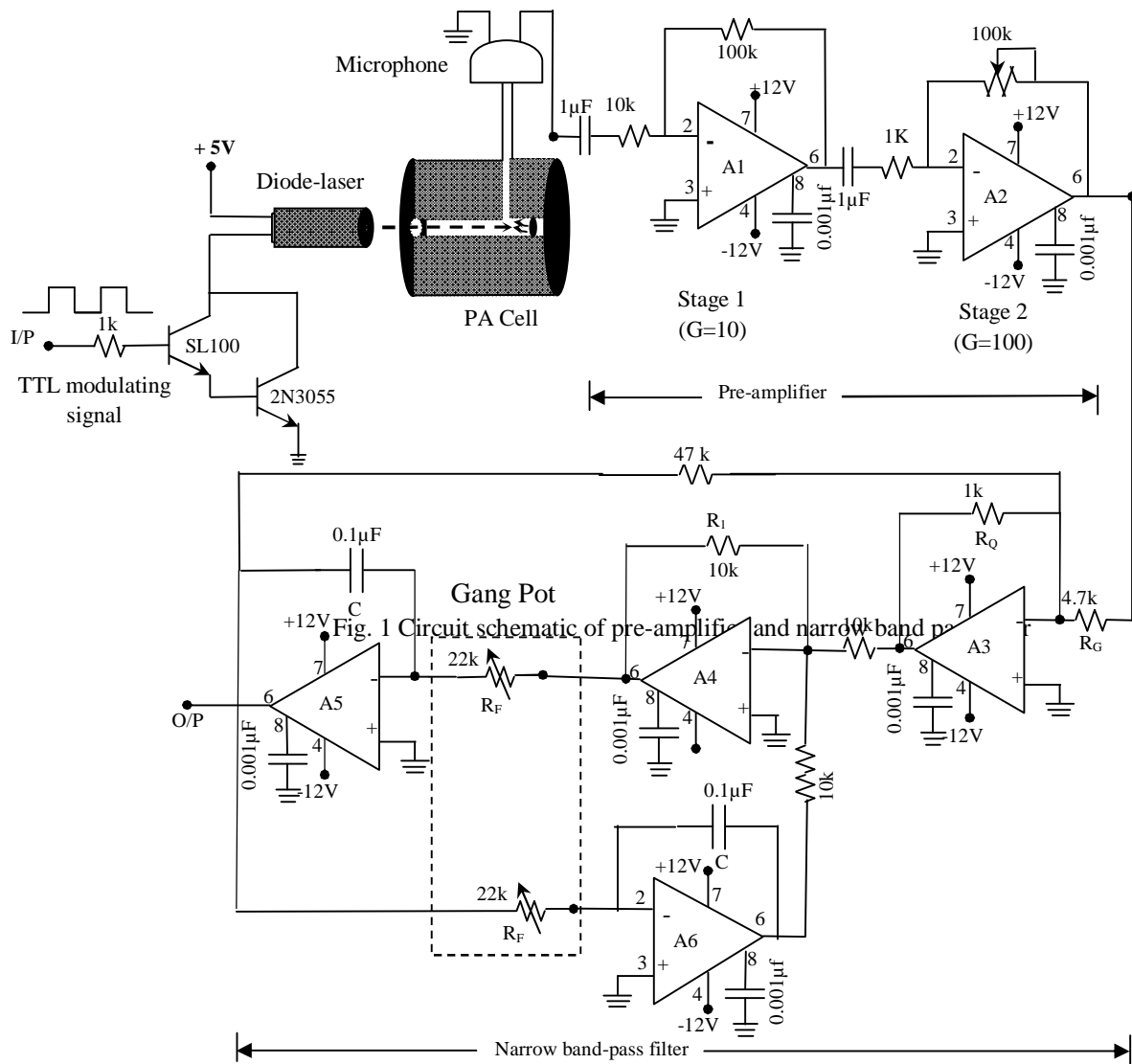

Fig. 2 Photograph of the PA cell

Pre-amplifier:

The microphone signal is usually very small in amplitude in the order of micro volt. Hence, it is amplified by the pre-amplifier with high input impedance, high-gain and low-noise. Since, LM308 has these qualities; the pre-amplifier is built around op-amp LM308. The pre-amplifier is designed with two stages to improve the gain-band-width product of the amplifier. The op-amps A1 and A2 constitute two-stage-amplifier as shown in Fig. 1. It has gain of 10 in first stage and 100 in second stage with a total gain of 1000. The gain of the pre-amplifier can be varied by varying the potentiometer connected in the feedback of the op-amp A2. The signal obtained from the pre-amplifier is normally associated with unwanted frequency components, but to get output at one particular frequency these unwanted frequencies are to be eliminated. This band of unwanted frequencies is eliminated by the tunable narrow band-pass filter which improves the signal-to-noise ratio of the circuit [23].

Narrow Band Pass Filter:

As shown in Fig. 1 the op-amp A3, A4, A5 and A6 constitutes narrow band-pass filter. The narrow band-pass filter, in spite of large number of components, is a good choice for very sharp (high-Q) band-pass filters. It has low component sensitivities, do not make great demands on operational amplifiers band-width and it is easy to tune such filters [24]. The important advantage of narrow band-pass filter is that, its bandwidth (i.e., Q) can be adjusted without affecting the mid-band gain. In fact, both Q and gain are set with a single resistor each (R_Q and R_G). Q, gain and center frequency are completely independent and are given by the following simple equations.

$$f_o = 1/(2\pi R_F C) \quad \dots\dots\dots (1)$$

$$Q = R_i/R_Q \quad \dots\dots\dots (2)$$

$$G = R_1/R_G \quad \dots\dots\dots (3)$$

The present circuit is designed for $Q=50$ and $G=10$. In this circuit a ganged potentiometer is used as feed-back resistor (R_F). By varying the ganged potentiometer, center frequency can be adjusted to the desired value. With this arrangement, the frequency range from 10Hz to 600Hz can be covered which is well beyond the range required for the present study. The amplitude of the signal is measured by displaying it on the CRO.

III. EXPERIMENTAL RESULTS

The resonance frequency of the PA cell is found experimentally by varying the chopping frequency of the laser source by applying square wave to the base of the Darlington pair transistor. The modulating frequency of the laser beam is varied from 10 to 600Hz and amplitude of the PA signal after passing through the pre-amplifier is measured as a function of frequency. Fig. 3 shows the PA cell response. A graph is plotted between frequency and amplitude of the PA signal. The graph shows that the PA signal amplitude is maximum at 345 Hz. This sharp increase in the amplitude of the PA signal around 345Hz indicates the characteristic volume resonance of the PA cell.

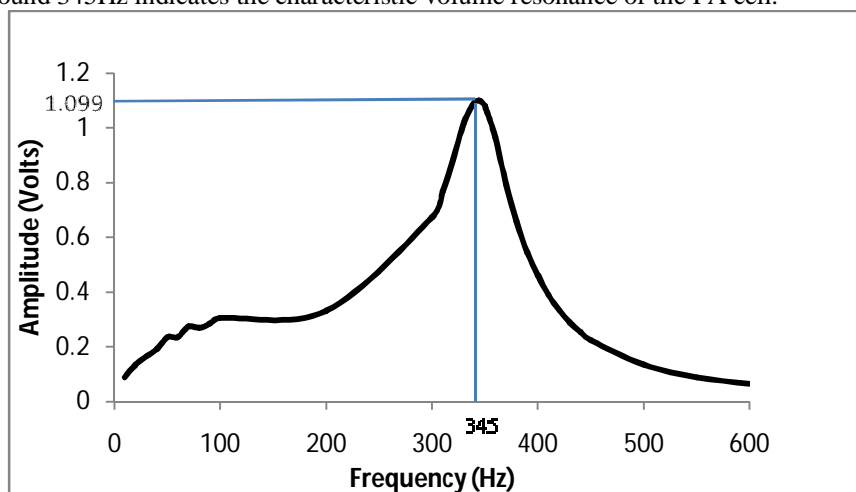

Fig. 3 The Frequency response of PA cell

The acoustic signals of carbon and 50.6 liquid crystal are measured by placing the glass plate coated with carbon soot and liquid crystal sample 50.6 in PA cell separately. The corresponding outputs of the two samples at the pre-amplifier

International Journal of Advanced Research in Electrical, Electronics and Instrumentation Engineering

(An ISO 3297: 2007 Certified Organization)

Vol. 3, Issue 11, November 2014

and filter are displayed on the CRO for further analysis. The pre-amplifier and narrow band-pass filter are tested in both the presence and absence of the modulated laser beam.

The response of the PA cell for carbon black sample at the output of pre-amplifier is as shown in Fig.4(a) and (b) shows the output of the pre-amplifier when the modulated laser beam is absent.

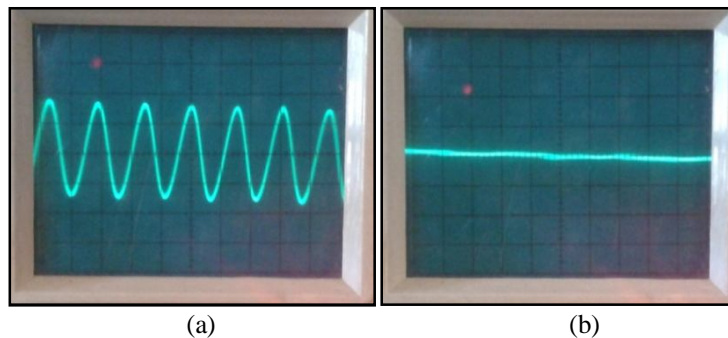

Fig. 4 The pre-amplifier output for carbon sample (a) in presence (b) in absence of modulated laser beam

The photographs of PA cell response for carbon black sample at the output of narrow band-pass filter in the presence and absence of modulated laser beam are shown in Fig. 5(a) & (b) respectively. The photographs show that the signal strength is high and signal is stable at pre-amplifier and band-pass filter output. Because the carbon sample absorbs more light and produces large acoustic signal, when the laser beam is absent then there is small noise at the output of the pre-amplifier but no noise at the output of band-pass filter.

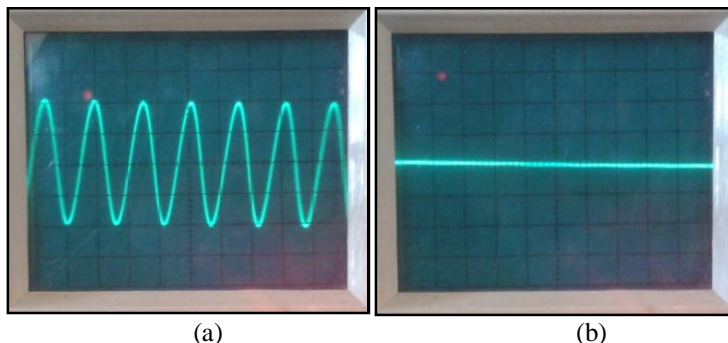

Fig. 5 The narrow band-pass filter output for carbon sample (a) in presence (b) in absence of modulated laser beam

The frequency response of the PA cell for liquid crystal sample 5O.6 at pre-amplifier output along with unwanted frequency components is shown in Fig. 6(a) and pre-amplifier output when the modulated laser beam is absent is shown in Fig. 6(b).

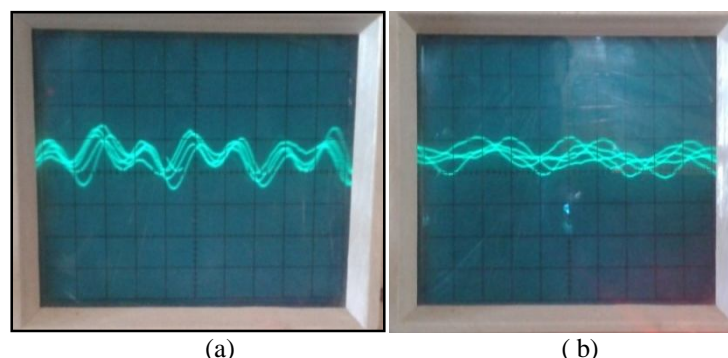

Fig. 6 The pre-amplifier output for 5O.6 sample (a) in presence and (b) in absence of modulated laser beam

International Journal of Advanced Research in Electrical, Electronics and Instrumentation Engineering

(An ISO 3297: 2007 Certified Organization)

Vol. 3, Issue 11, November 2014

The frequency response of the PA cell for liquid crystal sample 5O.6 at narrow band-pass filter output is shown in Fig. 7(a) and filter output when the modulated laser beam is absent is shown in Fig. 7(b). The photographs clearly show that the unwanted frequencies are eliminated by the narrow band-pass filter.

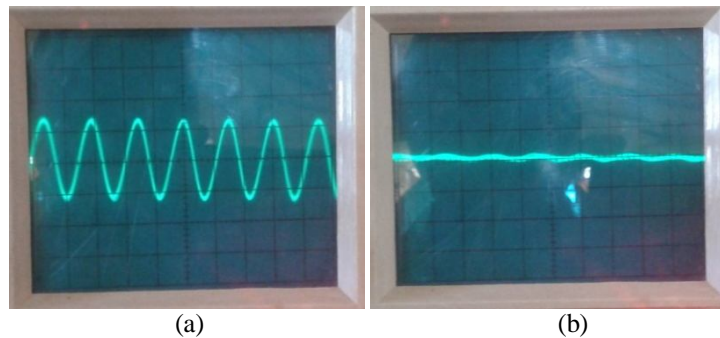

Fig. 7 The narrow band-pass filter output for 5O.6 sample (a) in presence and (b) in absence of modulated laser beam

IV. CONCLUSIONS

A high gain low-noise two-stage pre-amplifier and narrow band-pass filter circuits are designed and fabricated. The pre-amplifier has gain of 1000 to amplify the PA signal for the present photoacoustic spectrometer. The narrow band-pass filter with $Q=50$ and $G=10$ has been designed to eliminate noise components present in the PA signal. These circuits have improved the stability, sensitivity, signal strength, and signal-to-noise ratio of the PA signal which are essential qualities for the photoacoustic spectrometer applications.

Acknowledgements:

Authors are thankful to Prof.V.G.K.M.Pisipati, Director, Center for Liquid Crystal Research and Education, Nagarjun University, Guntur for providing the liquid crystal samples.

REFERENCES

1. Rangan C. S., Sharma G.R., and Mani V.S.V., "Instrumentation Devices and Systems", Tata McGraw-Hill Publishing Company Ltd., New Delhi, 300, 1997.
2. Raman K. Attri., "Evaluation of Single Op-Amp Topologies for Extremely Narrow Band-Pass Filter Design", Instrumentation Design Series (Electronics), Paper No. 3, September, 2005.
3. S. Cova, M. Ghioni, and F. Zappa, "Preamplifier- Introduction", Rev. Sci. Instrum. vol. 62, no. 11, pp. 2596–2601, Nov. 1991,.
4. Goldan P. and Goto K., "An acoustically resonant system for detection of low-level infrared absorption in atmospheric pollutants", Journal of Appl. Phys., vol. 45, pp. 4350-4355, Oct. 1974.
5. Smith R. A. Jones F. E. and Charmar R. P., "The Detection and Measurement of Infra-Red Radiation", Oxford University, London, 1968.
6. Voigtman E. et al, "Condensed phase photoacoustic detection of porphyrins and dyes ", Anal. Chem., vol. 53, pp. 1442-1446, 1981.
7. Beitz j V. et al, "High sensitivity photoacoustic spectrometer for variable temperature solution studies ", Rev. Sci. Instrum., vol. 61, pp. 1395-1403, 1990.
8. Chakrpani G. et al, " Sensitive gas-phase photoacoustic spectrometer with provision for simultaneous recording of absorption spectrum", Rev. Sci. Instrum., vol. 58, no. 58, pp. 1871-1877, 1987.
9. Clyton G. B., "Operational Amplifiers", Butterworth Scientific, London, 305, 1982.
10. Cheng-Cheh Yu., "Novel compact elliptic-function narrow-band band pass filters using microstrip open-loop resonators with coupled and crossing lines", IEEE Transactions on Microwave Theory and Techniques, vol. 46, no. 7, pp. 952-958, July 1998.
11. Andrea Melloni and Mario Martinelli. "Synthesis of Direct-Coupled-Resonators Band pass Filters for WDM Systems", Journal of Light wave Technology, vol. 20, no. 2, pp. 296-301, 2002.
12. Huelsmn L. P., "Theory and Design of Active R.C. Networks", McGraw, 1968.
13. Tobey Graeme, J. G. and Huelsman L. P., "Operational Amplifier Design Applications", McGraw Hill, 1971.
14. Nibu A.George, Vallabhan, and Radhakrishnan P., "Laser induced photoacoustic technique for the detection of phase transition in liquid crystals", Nondestructive testing and evaluation. vol. 17. pp. 315-324, 2001.
15. Lakshminarayan, S. Gouthami K., "Photoacoustic spectrometer for the determination of phase transition in solids and liquids", J. of Instrum. Soc of India, vol. 39, no.1, pp.59-61, 2009.
16. Kurihara, Y., Watanabe, K., Terada, Nakamura, T., "Design of a pre-amplifier for capacitive sensors with wide low-frequency range and low-drift noise" Sensors Journal, IEEE. vol. 12, no. 2, pp 378-383, July 2011.
17. Jawed, S.A., Neilsen, J.H., Gottardi, M., Baschiroto, A., "A multifunction low-power pre-amplifier for MEMS capacitive microphones," Proceedings of ESSCIRC '09 IEEE publishers, pp. 292-295, Sep. 2009.
18. Reiger, R., Taylor, J., Demosthenous, A., Donaldson, N., "Design of a low-noise pre-amplifier for nerve cuff electrode recording," Solid- State Circuits, IEEE Journal, vol. 38, no. 8 , pp. 1373-1379, Aug. 2003.



International Journal of Advanced Research in Electrical, Electronics and Instrumentation Engineering

(An ISO 3297: 2007 Certified Organization)

Vol. 3, Issue 11, November 2014

19. Hunter I.C. and Rhodes J. D., "Electronically Tunable Microwave Bandpass Filters," IEEE Transactions on Microwave Theory and Techniques, vol. 30, no. 9. pp. 1354-1360, Sep. 1982 .
20. Matthaei, G. L.; Supercond. Technol. Inc., Santa Barbara, "Narrow-band, fixed-tuned, and tunable bandpass filters with zig-zag harpin-comb resonators" IEEE Transactions on Microwave Theory and Techniques, vol. 51, no. 4, pp. 1214-1219, Apr 2003,
21. Almond D P, Patel P M, "Photo Thermal Science and Technique," Chapman and Hall, London, 1996.
22. P. Bhaskar, Immanuel J., and Bhagyajyoti, "Design and development of microcontroller based photoacoustic spectrometer," Sensors and Transducers, vol.141, pp. 26-34, 2012.
23. P. Bhaskar, "Design and development of computer based Instrumentation system for photoacoustic studies," Ph.D. Thesis, Sri Krishnadevaraya University, Anantapur, August 2000.
24. Paul Horowitz and Winfield Hill, "The art of Electronics," Cambridge University Press, (1994).
25. http://www.ksa.com/ks_electret_microphone.html

BIOGRAPHY

Sapna completed her M.Sc. and M.Phil in Instrumentation Technology, from Gulbarga University. Presently, she is pursuing Ph.D. under the guidance of Dr. P. Bhaskar, Professor, Department of Instrumentation Technology, Gulbarga University Post Graduate Centre, Raichur.

P. Bhaskar received the M.Sc., M.Phil., and Ph.D. degrees in Instrumentation from Sri Krishnadevaraya University, Anantapur, AP, India, Currently, he is a Professor in the Department of Instrumentation Technology at Gulbarga University Post Graduate Centre, Raichur, KA, India. He has published more than 50 papers in journals of national/international repute and presented over 22 papers in national/ international conferences. He has also authored a book on 8051 microcontroller. His research interests include Scientific Instrumentation, Embedded Systems, and Intelligent Control Systems. He is a member of the Instrument Society of India.

Parvathi C. S. received the B.E. degree in Instrumentation Technology from PDA College of Engineering, Gulbarga University, KA, M.Tech. degree in Instrumentation and Control Engineering from REC, Calicut, and Ph.D. degree in Applied Electronics from Gulbarga University, Gulbarga, KA, India. Currently, she is a Professor and Chairperson of the Department of Instrumentation Technology at Gulbarga University Post Graduate Centre, Raichur, KA, India. She has published more than 30 papers in journals of national/international repute. Her research interests include Fuzzy Control Systems, PC/DSP/ MATLAB based measurement and control, and process/ industrial control instrumentation. She is a member of Instrument Society of India.

Immanuel J. completed his M.Sc. and M.Phil. and Ph.D. degrees in Instrumentation Technology, from Gulbarga University. Presently working as a Guest lecturer. in the Department of Instrumentation Technology at Gulbarga University Post Graduate Centre, Raichur, KA, India. He has published 11 papers in journals of national/international repute and presented 2 papers in national/ international conferences. He is life member of Instrument Society of India, IISc Bangalore.