

Corrosion Resistance of Metal and Alloy in Artificial Urine in Presence of Sodium Chloride

R.Nagalakshmi¹, S.Rajendran² J.Sathiyabama³

Assistant Professor, Department of Chemistry, Aarupadai Veedu Institute of Technology,
Chennai-603104, Tamilnadu, India¹

Professor, PG and Research Department of Chemistry, GTN Arts College, Dindigul-624 005, Tamilnadu, India.

Research Centre RVS School of Engineering and Technology, Dindigul -624 005, Tamilnadu, India²

Associate Professor, PG and Research Department of Chemistry, GTN Arts College,
Dindigul-624 005, Tamilnadu, India³

Abstract: Corrosion resistance of two metals namely mild steel (MS), Nickel Titanium super elastic alloy has been evaluated in artificial urine in the absence and presence of sodium chloride. AC impedance spectra have been used to investigate the corrosion behaviour of these metals. The order of corrosion resistance of metals in artificial urine, in the absence and also in the presence of sodium chloride was Ni-Ti super elastic alloy > mild steel.

Keywords: Mild steel (MS), Nickel Titanium super elastic alloy, artificial urine, sodium chloride.

I.INTRODUCTION

Metallic biomaterials are commonly used in reconstruction in the orthopedic and dental surgery, operative cardiology and urology. Implant alloys exhibit attractive properties such as mechanical strength and biocompatibility, corrosion resistance, safety, ductility, and wear resistance. Stainless steels, titanium alloys and cobalt alloys are commonly used as biomaterials [1]-[7] Biocompatibility of implants in tissue environment is determined by inseparable biochemical, biomechanical and bioelectronic factors. Biological reactions are analyzed with respect to metabolic, bacteriological, immunological and oncological processes [8], [10]-[13], [15]-[17], [19]-[25], [28]. Current chemical compositions of the stainless steel (Cr-Ni-Mo) should ensure good pitting corrosion resistance and monophasic austenitic structure. The austenite grain size (less than 4 μ m to ISO) and non-metallic inclusions (max. 1.5 μ m to ISO) are limited. Fine grain and low level of non-metallic inclusions ensure good mechanical properties and reduce crackability, specially in implants with small cross-sections. They also increase corrosion resistance of implants [16], [17], [23]. Great number of publications is austenitic focused on generalization of corrosion failure of implants. These analyses are focused on implants commonly used in reconstruction in the orthopedic, dental surgery, operative cardiology and urology. These implants are mainly made of stainless steel [8], [9], [12], [14], [18], [26]-[28]. Long-term research on corrosion of implants made of the mentioned steel show the complexity of corrosion processes depending on the implant form, its chemical and phase composition, surface condition, surgical procedure and implantation period [16], [17], and [23]. Corrosion products infiltrate tissues. This process is called metallosis [10]. Phatomorphological changes, dependent on the type and concentration of elements, occur in tissues close to implant. Histopathological changes are observed in the detoxication organs (liver, kidneys, spleen) [16]. Therefore, corrosion tests in simulated body fluids are the basis for searching optimal fields of usage and improvement of existing solutions. In general the human urine contains sodium chloride and also excreted by the human body. In this research paper, if the person undergone implantation in the urinary tract how the metal undergoes corrosion in the presence of excess amount of sodium chloride. The present work was undertaken to study the corrosion behavior of two metals namely mild steel (MS), Nickel Titanium super elastic alloy in artificial urine, in the absence and presence of 50ppm and 100ppm of sodium chloride by AC impedance

spectra. Corrosion parameters such as charge transfer resistance, double layer capacitance and impedance value have been derived from these studies.

II. EXPERIMENTAL

A. Materials and Methods

Two metals namely mild steel (MS), Nickel Titanium super elastic alloy were chosen for the present study. The composition of mild steel was (wt %): 0.026S, 0.06P, 0.4 Mn, 0.1 C and balance iron (ArockiaSelvi et.al. 2009) [29]. The composition of Ni-Ti super elastic alloy was (wt %) Ni 55.5, and balance Ti [30]. The metal specimens were encapsulated in Teflon. The surface area of the exposed metal surface was 0.0785 cm². The metal specimens were polished to mirror finish and degreased with trichloroethylene. The metal specimens were immersed in artificial urine (AU) (J. Przondziona et al, 2009) [31], whose composition was: Solution A: CaCl₂.H₂O - 1.765g/l, Na₂SO₄ - 4.862g/l, MgSO₄.7H₂O - 1.462g/l, NH₄Cl - 4.643g/l, KCl - 12.130g/l. Solution B: NaH₂PO₄.2H₂O - 2.660g/l, Na₂HPO₄ - 0.869 g/l, C₆H₅Na₃O₇.2H₂O - 1.168 g/l, NaCl - 13.545 g/l. The pH of the solution was 6.5 (W.Kajzer et al, 2006) [5].

In electrochemical studies the metal specimens were used as working electrodes. Artificial urine (AU) was used as the electrolyte (10 ml). The temperature was maintained at 37±0.1°C. Commercially available sodium chloride was used in this study. 50ppm and 100ppm of sodium chloride was used in artificial urine.

B. AC Impedance Spectra

The instruments used for polarization study was used to record AC impedance spectra also. The cell set up was the same. The real part (Z') and imaginary part (Z'') of the cell impedance were measured in ohms at various frequencies. Values of the charge transfer resistance (R_t) and the double layer capacitance (C_{dl}) were calculated from Nyquist plots. Impedance log (Z/ohms) value was calculated from Bode plots

III. RESULTS AND DISCUSSION

AC Impedance Spectra

1. Corrosion resistance of Mild steel in AU in presence of NaCl: AC impedance parameters such as charge transfer resistance (R_t), double layer capacitance (C_{dl}) (derived from Nyquist plots) and impedance value logz/ohm (derived from Bode plots) of MS immersed in AU and AU containing sodium chloride are given in Table.1. The AC impedance spectra are shown in Fig.1a, 1b, 1c (Nyquist plots) 2, 3, 4 (Bode plots).

TABLE.I

Corrosion Parameters of MS Immersed in AU in Absence and Presence of Sodium Chloride Obtained from AC Impedance Spectra.

System	Nyquist Plot		Bode Plot
	R _t ohmcm ²	C _{dl}	Log Z/ohm
AU	172	2.97x10 ⁻⁸	2.28
AU+50ppm NaCl	136	3.74x10 ⁻⁸	2.18
AU+100ppm NaCl	135	3.77x10 ⁻⁸	2.15

It is observed from the table that when sodium chloride is added to AU the R_t value decreases, the C_{dl} value increases (Nyquist plot). This indicates that in presence of sodium chloride, the corrosion resistance of MS decreases. This is further supported that in presence of sodium chloride the impedance value (Logz/ohm) decreases. Further the phase angle value decreases (Bode plots). The AC impedance spectra leads to the conclusion that in the presence of sodium chloride the corrosion resistance of MS in AU decreases. So the use of MS in presence of sodium chloride in urology should be avoided. Otherwise MS will undergo corrosion and it will leads to many problem

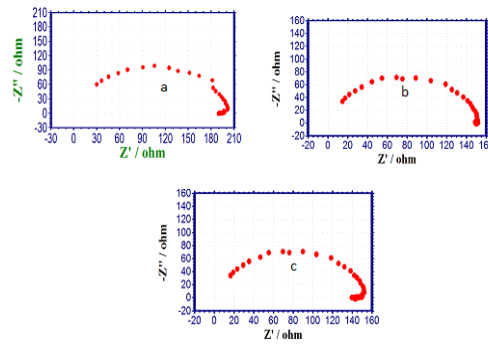

Fig. 1.AC impedance spectra (Nyquist plots) of MS immersed in
 a) AU b) AU+ 50ppm NaCl c) AU+ 100ppm NaCl

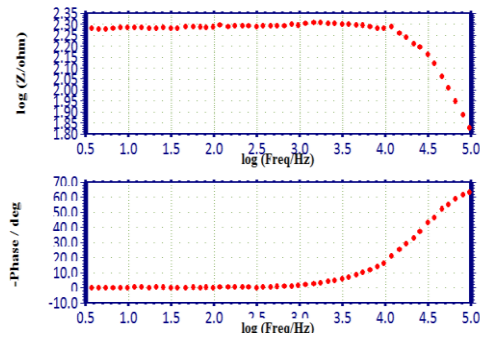

Fig. 2 AC impedance spectra (Bode plots) of MS immersed in AU

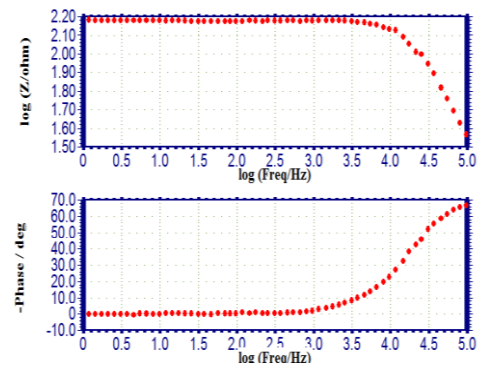

Fig. 3 AC impedance spectra (Bode plots) of MS immersed in AU +50ppm NaCl

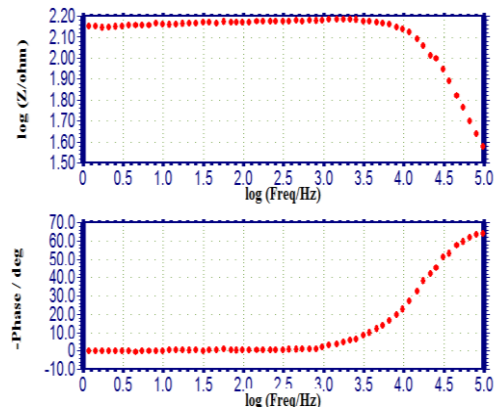
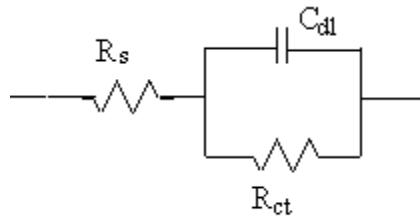

Fig. 4 AC impedance spectra (Bode plots) of MS immersed in AU +100ppm NaCl

The equivalent circuit diagram for the above three system is shown in scheme 1.



C_{dl} – Double layer capacitance.

R_s – Solution resistance

R_{ct} – Charge transfer resistance

2. Corrosion resistance of Ni-Ti Superelastic in AU in presence of NaCl : AC impedance parameters such as charge transfer resistance (R_t), double layer capacitance (C_{dl}) (derived from Nyquist plots) and impedance value $\log z/\text{ohm}$ (derived from Bode plots) of Ni-Ti superelastic alloy immersed in AU and AU containing sodium chloride are given in Table.2. The AC impedance spectra are shown in Fig.5a, 5b, 5c (Nyquist plots) 6, 7, 8 (Bode plots).

TABLE.2

Corrosion Parameters of Ni-Ti Superelastic Alloy Immersed in AU in Absence and Presence of Sodium Chloride Obtained from AC Impedance Spectra.

System	Nyquist Plot		Bode Plot
	R_t ohmcm ²	C_{dl}	Log z/ohm
AU	3.50×10^5	1.45×10^{-11}	6.38
AU+ 50ppm NaCl	2.54×10^4	2.00×10^{-10}	5.19
AU+ 100ppm NaCl	3.08×10^4	1.65×10^{-10}	5.22

It is observed from the table that when sodium chloride is added to AU the R_t value decreases, the C_{dl} value increases (Nyquist plot). This indicates that in presence of sodium chloride, the corrosion resistance of Ni-Ti superelastic alloy decreases. This is further supported that in presence of sodium chloride the impedance value ($\text{Log}z/\text{ohm}$) decreases. Further the phase angle value decreases (Bode plots) [32], [33].The AC impedance spectra lead to the conclusion that in the presence of sodium chloride the corrosion resistance of Ni-Ti superelastic alloy in AU decreases.

The enlarged graph in the high frequency region of Figures 5a, 5b, 5c are shown in Figures 5a.1, 5b.1, 5c.1 respectively. It is observed from these graphs that the reactions are diffusion controlled processes that is diffusion of ions from the bulk of the solution towards the metal surface. The equivalent circuit diagram for such system is shown in scheme.2.

It is observed that the graphs seen in Fig.5a, 5b, 5c are very close to that of very corrosive protective system (insulator). That is electron transfer from metal to system is very difficult. Since the protective film formed on the metal surface is very stable and compact.

It is observed from the impedance Bode plots (Fig.6, 7, 8) that the value of impedance decreases sharply as the $\log z$ value increases. The slope of the line in the middle frequency region is 0.5. This is characteristic of very protective film [34].

The equivalent circuit diagram for such system is shown in scheme.2

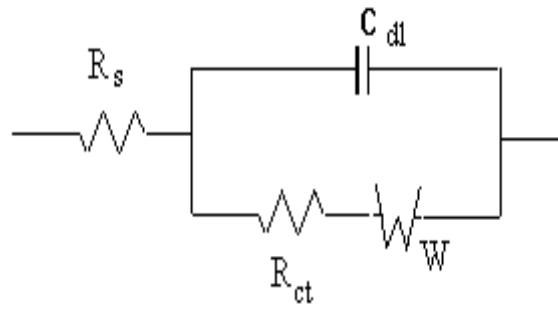

R_s – Solution resistance

R_{ct} – Charge transfer resistance

W – Warburg diffusion resistance

C_{dl} – Double layer capacitance

Scheme 2.

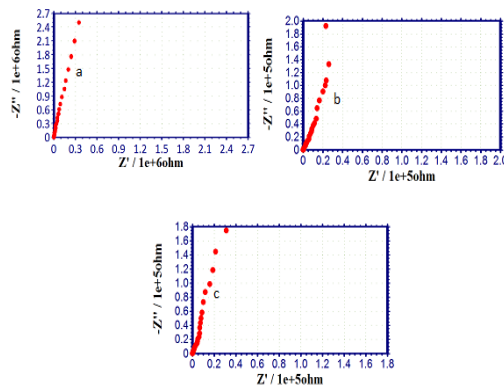

Fig. 5 AC impedance spectra (Nyquist plots) of Ni-Ti Super elastic immersed in AU

- a) AU
- b) AU+ 50ppm NaCl
- c) AU+ 100ppm NaCl

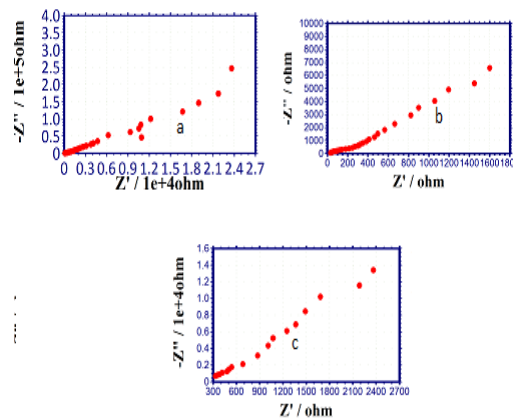

Fig. 5 AC impedance spectra (Nyquist plots) of

- a.1) Ni-Ti superelastic immersed in AU
- b.1) Ni-Ti superelastic immersed in AU +50ppmNaCl
- c.1) Ni-Ti superelastic immersed in AU +100ppm NaCl

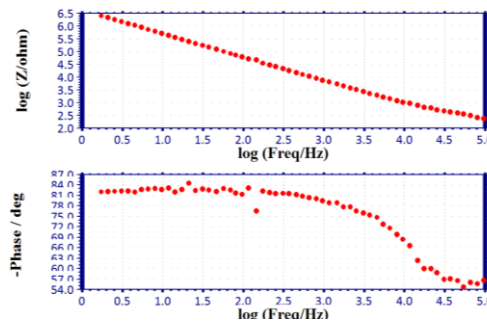

Fig.6 AC impedance spectra (Bode plots) of Ni-Ti super elastic alloy immersed in AU

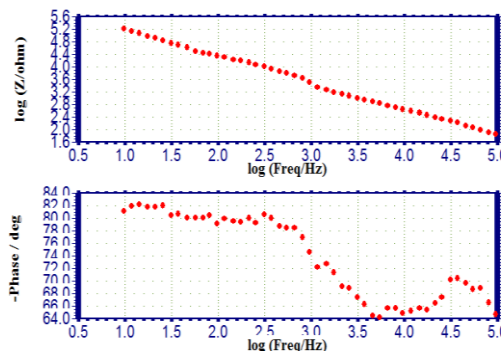

Fig.7 AC impedance spectra (Bode plots) of Ni-Ti super elastic alloy immersed in AU+50ppm NaCl

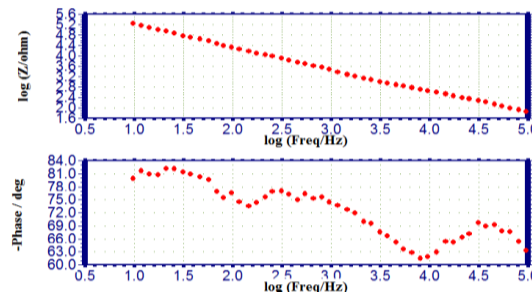

Fig.8 AC impedance spectra (Bode plots) of Ni-Ti super elastic alloy immersed in AU+100ppm NaCl

IV.CONCLUSION

AC impedance spectra have led to the following conclusions: In the absence of sodium chloride the order of corrosion resistance was: Ni -Ti super elastic>Mild steel. In the presence of 50ppm and 100ppm of sodium chloride, the order of corrosion resistance was: Ni-Ti super elastic >Mild steel. Ni-Ti super elastic was more corrosion resistant in the absence of sodium chloride than in the presence of sodium chloride. Mild steel was less corrosion resistant in the presence of sodium chloride and in the absence of sodium chloride

ACKNOWLEDGEMENT

The authors are thankful to their Managements and St. Joseph’s Research and Community Development Trust, Dindigul, India for their help and encouragement

REFERENCES

[1] Z. Paszenda, J. Tyrlik-Held, J. Marciniak, A. Wodarczyk, *Corrosion resistance of Cr-Ni-Mo steel intended for implants used in operative cardiology, Proceedings of the 9th International Scientific Conference “Achievements in Mechanical and MaterialsEngineering2000”*, Gliwice-Sopot-Gdańsk, 2000, 425-428.
[2] J. Szewczenko, J. Marciniak, *Corrosion of Cr-Ni-Mo steel implants electrically stimulated*, Journal of Materials Processing Technology 175 (2006) 404-410.

- [3] W. Walke, Z. Paszenda, J. Tyrlik-Held, *Corrosion resistance and chemical composition investigations of passive layer on the implants surface of Co-Cr-W-Ni alloy*, Journal of Achievements in Materials and Manufacturing Engineering 16 (2006) 74-79.
- [4] W. Chrzanowski, *Corrosion behavior of Ti6Al7Nb alloy after different surface treatments*, Journal of Achievements in Material and Manufacturing Engineering 18 (2006) 67-70.
- [5] W. Kajzer, A. Krauze, W. Walke, J. Marciniak, *Corrosion resistance of Cr-Ni-Mo steel in simulated body fluids*, Journal of Achievements in Materials and Manufacturing Engineering 18 (2006) 115-118.
- [6] E. Krasicka-Cydzik, K. Kowalski, I. Glazowska, *Electrochemical formation of bioactive surface layer on titanium*, Journal of Achievements in Materials and Manufacturing Engineering 18 (2006) 147-150.
- [7] A. Krauze, A. Zi \square bowicz, J. Marciniak, *Corrosion resistance of intramedullary nails used in elastic osteosynthesis of children*, Journal of Achievements in Materials and Manufacturing Engineering 13 (2005) 355-358.
- [8] W. Kajzer, J. Marciniak, *Biomechanical FEM analysis of stent-urethra system*, proceedings of the 19th International Scientific Conference „European Conference on Biomaterials” ESB’2005, Sorrento, 2005, 618-619.
- [9] W. Kajzer, J. Marciniak, *Biomechanical analysis of urological stent*, Engineering of Biomaterials 47-53 (2005) 141-143.
- [10] W. Kajzer, W. Chrzanowski, J. Marciniak, *Corrosion resistance of Cr-Ni-Mo steel intended for urological stents*, Proceedings of the 11th International Scientific Conference „Contemporary Achievements in Mechanics, Manufacturing and Materials Science” CAM3S’2005, Gliwice – Zakopane, 2005, 444-449.
- [11] W. Kajzer, M. Kaczmarek, A. Krauze, J. Marciniak, *Surface modification and corrosion resistance of Ni-Ti alloy used for urological stents*, Journal of Achievements in Materials and Manufacturing Engineering 20 (2007) 123-126.
- [12] W. Kajzer, M. Kaczmarek, J. Marciniak, *Biomechanical analysis of stent - oesophagus system*, Journal of Materials Processing Technology 162-163 (2005) 196-202.
- [13] W. Kajzer, A. Krauze, W. Walke, J. Marciniak, *Corrosion resistance of Cr-Ni-Mo steel in simulated body fluids*, Journal of Achievements in Materials and Manufacturing Engineering 18 (2006) 115-118.
- [14] A. Krauze, W. Kajzer, J. Marciniak, *Biomechanical characteristics of intramedullary nails – femur system with the use of FEM*, *Proceeding of the 12th International Scientific Conference “Achievements in Mechanical and Materials Engineering” AMME’2003*, Gliwice – Zakopane, 2003, 533-538.
- [15] A. Krauze, A. Zi \square bowicz, J. Marciniak, *Corrosion resistance of intramedullary nails used in elastic osteosynthesis of children*, Journal of Materials Processing Technology 162-163 (2005) 209-214.
- [16] J. Marciniak, *Perspectives of employing of the metallic biomaterials in the reconstruction surgery*, Engineering of Biomaterials 1 (1997) 12-20.
- [17] J. Marciniak, Biomaterials, Silesian University of Technology Press, Gliwice, 2002 (in Polish).
- [18] J. Marciniak, A. Zi \square bowicz, A. Krauze, *Biomechanical characteristics of intramedullary nails – bone system in simulated laboratory conditions*, Proceedings of the 9th International Scientific Conference „Achievements in Mechanical and Materials Engineering” AMME’2000, Gliwice – Sopot – Gdansk, 2000, 367-370.
- [19] Z. Paszenda, J. Tyrlik-Held, *Corrosion resistance of coronary stents made of Cr-Ni-Mo steel*, Proceedings of the 10th International Scientific Conference „Achievements in Mechanical and Materials Engineering” AMME’2001, Gliwice – Krakow – Zakopane, 2001, 453-460.
- [20] Z. Paszenda, J. Tyrlik-Held, *Forming the physicochemical properties of coronary stents surface*, Proceedings of the 13th Conference „European Society of Biomechanics” ESB’2002, Wroclaw, 2002, 539-540.
- [21] Z. Paszenda, J. Tyrlik-Held, *Coronary stents with passive and carbon layers*, Proceedings of the 17th International Scientific Conference „European Conference on Biomaterials” ESB’2002, Barcelona, 2002, 89-90.
- [22] Z. Paszenda, J. Tyrlik-Held, J. Marciniak, A. W \square odarczyk, *Corrosion resistance of Cr-Ni-Mo steel intended for implants used in operative cardiology*, Proceedings of the 9th International Scientific Conference “Achievements in Mechanical and Materials Engineering”, AMME’2000, Gliwice – Sopot – Gdansk, 2000, 425-428.
- [23] S.G. Steinemann, *Corrosion of surgical implants – in vivo and in vitro tests*, Evaluation of Biomaterials, John Wiley & Sons, New York, 1980.
- [24] J. Szewczenko, J. Marciniak, W. Chrzanowski, *Corrosion of Cr-Ni-Mo steel implants in conditions of sinusoidal current electro stimulation*, Proceedings of the 9th International Scientific Conference „Achievements in Mechanical and Materials Engineering” AMME’2000, Gliwice – Sopot – Gdansk, 2000, 511-514.
- [25] J. Szewczenko, J. Marciniak, W. Chrzanowski, *Corrosion damages of Cr-Ni-Mo steel implants in conditions of an alternating current electro stimulation*, Proceedings of the 10th International Scientific Conference “Achievements in Mechanical and Materials Engineering” AMME’2001, Gliwice – Krakow – Zakopane, 2001, 543-548.
- [26] W. Walke, W. Kajzer, M. Kaczmarek, J. Marciniak, *Stress and displacement analysis in conditions of coronary angioplasty*, Proceedings of the 11th International Scientific Conference „Achievements in Mechanical and Materials Engineering” AMME’2002, Gliwice – Zakopane, 2002, 595-600.

- [27] W. Walke, Z. Paszenda, J. Marciniak, *Optimization of coronary stent with the use of finite element method*, Proceedings of the 12th International Scientific Conference "Achievements in Mechanical and Materials Engineering" AMME'2003, Gliwice – Zakopane, 2003, 1011-1016.
- [28] W. Walke, Z. Paszenda, J. Marciniak, *Corrosion resistance of Co-Cr-W-Ni alloy designer for implants used in operative cardiology*, Engineering of Biomaterials 47-53 (2005) 96-99.
- [29] S.J.Arockia., S. Rajendran, V. Ganga Sri, A. John , B. Narayanasamy, *portugaliae Electrochemica Acta*.27(2009):p.1-11.
- [30]. M. Kaczmarek, J. Archive. Mater. Sci. Eng., Volume 28(5), (2007): p.269-272.
- [31]. J.Przondziono, W.Walke, J. Archive. Mater. Sci. Eng., Volume 35(1), (2009).
- [32] A. Leemrose, Peter pasgal Regis , Susai Rajendran, A. Krishnaveni ,Felicia Rajammal selvarani ,*Arabian journal for science and engineering*.37(2012):p.1313-1325.
- [33].V. Sribharathi and Susai Rajendran, Int. j. advances in engineering, science and Technology, Vol.1 No.1 (2011).
- [34] G.Gunasegaram, R. Natarajan, N. Palaniswamy, *corrosion science*43 (2001): p.1615-1626.

Biography



I have completed my M.Sc., degree in SRNM College Sattur, and M.Phil., degree in ANJA College, Sivakasi. I am working as Assistant Professor in Aarupadai Veedu Institute of Technology, Chennai. I have published five papers in National journal, and presented one paper in National conference and one paper in Inter National conference.

Publications:

- 1) R. Nagalakshmi[a], S. Rajendran[b,c], J. Sathiyabama[b], M. Pandiarajan[b]*, and J. Lydia Christy[d] "Corrosion behaviour of biomaterials insynthetic biological solutions – an overview" *Eur. Chem. Bull.* **2013**, 2(4), 171-179
- 2) R. Nagalakshmi[a], S. Rajendran[b,c], J. Sathiyabama[b], M. Pandiarajan[b]* and J. Lydia Christy[d] " Corrosion behaviour of metals in artificialurine in presence of sodium chloride" *Eur. Chem. Bull.*, 2013, 2(4), 150-153
- 3) R. Saranya[a], S. Rajendran [b,c]*, A. Krishnaveni[d], M. Pandiarajan[b],and R. Nagalakshmi[e] "Corrosion resistance of metals and alloys inartificial saliva – an overview"*Eur. Chem. Bull.* **2013**, 2(4), 163-170.
- 4) A. Sahaya Raja[a], S. Rajendran[b,c], R. Nagalakshmi[d], J. AngelinThangakani[e] and M.Pandiarajan [b] "Eco-friendly inhibitor glycine-zn²⁺ systemcontrolling corrosion of carbon steel in wellwater" *Eur. Chem. Bull.* **2012**, 1(3), 130-136
- 5) Rajendran S., Chitradevi P., Johnmary S., Krishnaveni A., Kanchana S., Christy Lydia, Nagalakshmi R., Narayanasamy B, "Corrosion behaviour of SS 316 L in artificial saliva in presence of electoral" *Zaštita materijala*, vol. 51, br. 3, str. 149-158, 2010