



## International Journal of Advanced Research in Electrical, Electronics and Instrumentation Engineering

(ISO 3297: 2007 Certified Organization)

Vol. 2, Issue 8, August 2013

# A HYBRID MODEL OF SOLAR-WIND POWER GENERATION SYSTEM

Sandeep Kumar<sup>1</sup>, Vijay Kumar Garg<sup>2</sup>

M.Tech. Scholar, Department of Electrical Engg. UIET, Kurukshetra University, Kurukshetra, Haryana, India<sup>1</sup>

Assistant Professor, Department of Electrical Engg. UIET, Kurukshetra University, Kurukshetra, Haryana, India<sup>2</sup>

**ABSTRACT:** This paper deals with the detailed of a hybrid model of a solar / wind in Simulink, which is using battery as its storage system. The simulation includes all realistic components of the system, in this system power delivered by the combine system component is compared with each other and various conclusions are drawn. A comparative study of hybrid model solar /wind system has been made. This paper describe of solar-wind hybrid system for supplying electricity to power grid. Work principle and specific working condition are presented in this paper.

**KEYWORDS :** Solar power, wind power, hybrid generation energy, grid

### I. INTRODUCTION

Energy is essential to our society to ensure our quality of life and to underpin all other elements of our economy. The escalation in cost and environmental concerns involving conventional electrical energy. Sources have increased interest in renewable energy sources. Many societies across the world in which we live have developed a large appetite for electrical energy. This appetite has been stimulated by the relative ease with which electricity can be generated, distributed, and utilized, and by the great variety of its applications. It is arguable whether the consumption of electricity should be allowed to grow unchecked, but the fact is that there is an ever-increasing demand for this energy form. Clearly, if this demand is to be met, then the world's electricity generating capacity will have to continue to grow. Presently almost all the electricity generation takes place at central power station which utilizes coal, oil, gas, water or fissile nuclear material as the primary fuel source. There are problem facing the further development of generating methods based on any of these "conventional fuels". Hydro-power generation is restricted to geographically suitable areas, and reserves of coal, although presently plentiful, are not renewable. The possible hazards of nuclear power have been much publicized, particularly those concerning the storage and military use of nuclear waste material. Nevertheless, to assist in maintaining electrical supply in many of our societies its seems likely that an increasing nuclear power presence, involving breeder and possibly fusion reactors, will be tolerated. To achieve this and also to aid in management of the existing fossil-fuel resources, it is essential that some part and an increasing part, of future electrical energy research and development be concerned with so called "nonconventional "methods of generation Wind- solar power generations are visible options for future power generation. Besides being free, they are free of recurring costs. They also offer power supply solutions for remote areas, not accessible by grid power supply today around 30,000 wind turbines and more than 1,00,000 off-grid solar PV systems are installed all over the world. Wind and solar hybrid model with proper storage system have been keen interest for the last few years. In this paper a hybrid model of solar / wind is developed using the battery. The simulation circuit will include all realistic components of the system.



ISSN (Print) : 2320 – 3765  
ISSN (Online): 2278 – 8875

# International Journal of Advanced Research in Electrical, Electronics and Instrumentation Engineering

*(ISO 3297: 2007 Certified Organization)*

**Vol. 2, Issue 8, August 2013**

## II. LITERATURE REVIEW

Hybrid models have been an effective means of producing generating electricity throughout the world. Lots of research work has been done and continuing the accommodate new advances in this system. This paper reports the probabilistic performance assessment of a wind, Solar Photo Voltaic (SPV) Hybrid Energy System. In addition to this solar/wind system with backup storage batteries were designed, integrated and optimized to predict the behavior of generating system.

This paper proposes a hybrid energy system combining solar photovoltaic and wind turbine as a small scale alternative source of electrical energy where conventional generation is not practical. Simulation of the hybrid system under investigation was carried out by using PSIM software. A simple and cost effective maximum power point tracking technique is proposed for the photovoltaic and wind turbines. This paper provides a core of a CAD/CAA tool that can help designers determine the optimal design of a hybrid solar power system for either autonomous or grid link applications. This technique uses linear programming principles to reduce the cost of electricity while meeting the load requirement. A controller that monitors the operation of autonomous/grid linked system is designed.

This paper presents a decision support technique to help the decision makers to study the influencing factors in design of a hybrid-solar power system (HSWPS) for grind linked applications. The analytic Hierarchy Process was used to quantify the various divergences of opinions, practices and events that lead to confusion and uncertainties in planning.

This paper provides a core of a CAD/CAA tool that can help designers determine the optimal design of a hybrid solar power system for either autonomous or grid link applications. This technique uses linear programming principles to reduce the cost of electricity while meeting the load requirement. A controller that monitors the operation of autonomous/grid linked system is designed.

In this paper the various advances in photovoltaic module technology inverts, system installation practices in improving the performance of PV systems and have led to PV becoming established as a strongly competitive energy source for off-grid energy applications. PV is also on the CUSP of becoming competitive in grid connect configuration. Moreover it also introduces the modern inverters that are more efficient, have higher reliability and improved utility. System interface features. It also introduces the various improvement in designs and economics in the PV system.

This paper describes the simulation of a combined wind – solar – hydro system for electric power generation with energy storage facilities. A simple multivariable weather model including the wind speed, the solar radiation and the rain fall was developed. This model is used to evaluate the reliability of the mixed generating system. Different percentages of wind and solar generation capacities were tried as well as the solar arrays.

This paper investigates the effects of kinetic wave – particle interactions on the solar wind using a global hybrid model. The model follows the evolution of the particle distribution along an inhomogeneous field line under the influence of wave – particle interactions, an am bipolar electric field that is consistent with the particle distributions themselves and coulomb collisions. This represents the “first results”: of global evolutionary study of the solar wind that take into account these kinetic effects. The model can account for the bulk acceleration of the solar wind.

In this paper Computer models of wind turbines for power system stability studies have been developed and supply to power system operators worldwide. The development of such models is of particular significance for stability studies on systems experiencing very large penetrations of wind energy such as the electricity system in the Republic of Ireland. There is a large variation in the complexity of models developed and no widespread agreement on the level of modeling detail required. The use of multiple wind turbine models for large-scale stability studies is also proving difficult. In addition, the majority of models have not been validated. This paper has examined model



# International Journal of Advanced Research in Electrical, Electronics and Instrumentation Engineering

(ISO 3297: 2007 Certified Organization)

**Vol. 2, Issue 8, August 2013**

development and use from the perspective of the Irish grid operator. The validation of developed models will be discussed, and a generic modeling approach will be proposed for large-scale power system stability.

This paper reports the development of a computer approach for evaluating the general performance of stand-alone wind / photovoltaic generating systems. Simple models for different system components are developed, integrated, and used to predict the behavior of generating systems based on available wind/solar and load data. The model is useful for evaluating the performance of stand-alone generating systems and gaining a better insight in the component sizes needed before they are built. Simulation results are presented for performance evaluation of a stand-alone generating system that has been previously designed to supply the average power demand of a typical residential house.

In this paper panel contribution, the modeling of wind turbines in power systems dynamics simulations is discussed. First the three most important actual wind turbine concepts are described. Then, various classes of wind turbine models are introduced and it will be discussed which model type can be integrated in power system dynamics simulation software. To conclude, it will be argued that it is possible to model various kinds of variable speed wind turbines with only one model in power system dynamics simulations.

In this investigation, wind turbine generators, photovoltaic panels, and storage batteries are used to build a grid-linked generation system which is optimal in terms of multiple criteria including cost, reliability, and emissions. Multidisciplinary design facilitates the decision maker to make more rational evaluations. A set of tradeoff solutions can be obtained using the multidisciplinary approach, which offers many design alternatives to the decision maker. A customized particle swarm optimization algorithm is developed to derive these non-dominated solutions. A grid-linked hybrid power system is designed based on the proposed approach.

### III. SOLAR PHOTOVOLTAIC SYSTEM

The European PV industry Association reported that the total global PV cell production worldwide in 2002 was over 560 MW and has been growing about 30% annually in recent years. The physical of PV cell is very similar to that of the classical diode with a PN junction formed by semiconductor material. When the junction absorbs light, the energy of absorbed photon is transferred to the electron-proton system of the material, creating charge carriers that are separated at the junction. The charge carriers in the junction region create a potential gradient, get accelerated under the electric field, and circulate as current through an external circuit. The solar cell is the basic building of the PV power system it produces about 1 W of power. To obtain high power, numerous such cell are connected in series and parallel circuits on a panel (module), the solar array or panel is a group of a several modules electrically connected in series parallel combination to generate the required current and voltage. The electrical characteristics of the PV module are generally represented by the current vs. voltage (I-V) and the current vs. power (P-V) curves. Figs. and show the (IV) and (P-V) characteristics of the used photovoltaic module at different solar illumination intensities.

The I– V characteristic of the PV module are:

$$I = I_L - I_0 \left( e^{q(V + I R_S) / nkT} - 1 \right)$$

Where  $I_L$  = photo current

$I_0$  = diode saturation current

$R_S$  = series resistance

$q$  = charge of electron

$k$  = constant

$T$  = temperature

$N$  = number of PV module

Power output from the PV array can be obtained by using the equation:

$$P_{pv}(t) = I_{ns}(t) * A * \text{Eff}(pv)$$



# International Journal of Advanced Research in Electrical, Electronics and Instrumentation Engineering

(ISO 3297: 2007 Certified Organization)

Vol. 2, Issue 8, August 2013

Where  $I_{ns}(t)$  = insolation data at time  $t$  ( $\text{kw}/\text{m}^2$ )

$A$  = area of single PV panel ( $\text{m}^2$ )

$\text{Eff}_{pv}$  = overall efficiency of the PV panels and dc/dc converters.

The Solar Cell Characteristics:

- $I_{sc}$ -short circuit current.
- $V_{oc}$ -open circuit voltage.
- Peak power
- The open circuit voltage of a single solar cell is approx 0.5V.
- Much higher voltage is required for practical application.
- Solar cells are connected in series to increase its open circuit voltage.

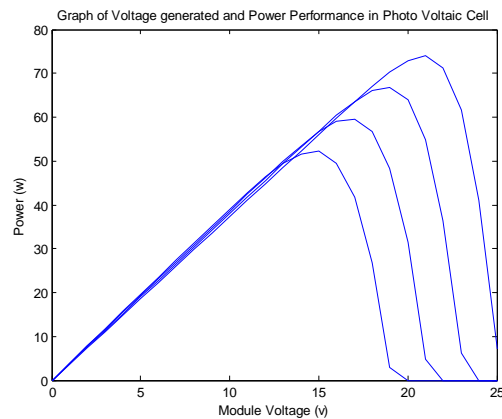
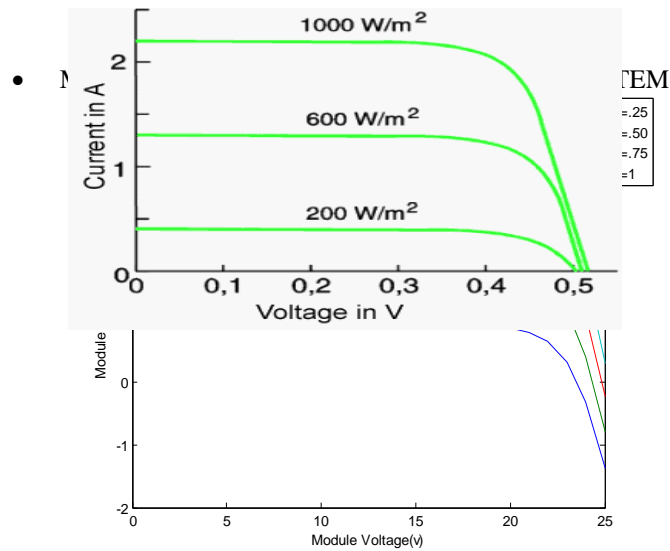



# International Journal of Advanced Research in Electrical, Electronics and Instrumentation Engineering

(ISO 3297: 2007 Certified Organization)

Vol. 2, Issue 8, August 2013

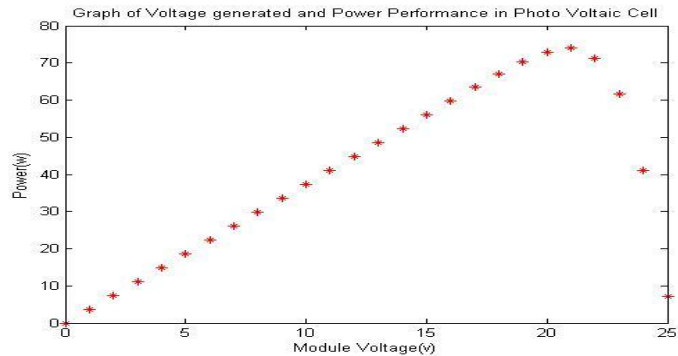

## IV. WIND ENERGY SYSTEM

Wind power systems convert the kinetic energy of the wind into other forms of energy such as electricity. Although wind energy conversion is relatively simple in concept, turbine design can be quite complex. Most commercially available wind turbine uses a horizontal – axis configuration with two or three blades, a drive train including a gearbox and a generator and a tower to support the rotor. Typical sizes for a wind turbine range from 200-750 KW, with electricity produce within a specific range of wind speed. Capital costs have declined from about \$ 2.2/w in early 1980 to less than \$ 1/w today. Cooperative research between DOE and manufacturing companies is aimed at increasing the aerodynamics efficiency and structural strength of wind turbine blades, developing variable speed generation and electronic power controls and using taller tower that allow access to the stronger wind found at greater height. An important factor in how much power your wind turbine will produce is the height of its tower. The power available in the wind is proportional to the cube of its speed. This means that if wind speed doubles, the power available to the wind generator increases by a factor of 8 ( $2 \times 2 \times 2 = 8$ ) Since wind speed increases with height increases to the tower height can mean enormous increases in the amount of electricity generated by a wind turbine.

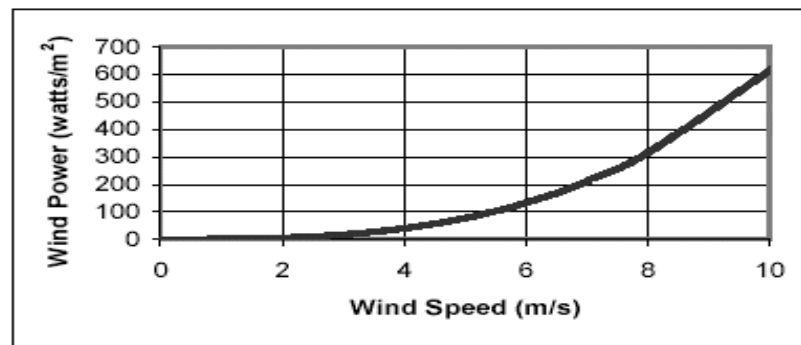

Figure Relationship between wind speed and wind power.



## International Journal of Advanced Research in Electrical, Electronics and Instrumentation Engineering

(ISO 3297: 2007 Certified Organization)

Vol. 2, Issue 8, August 2013

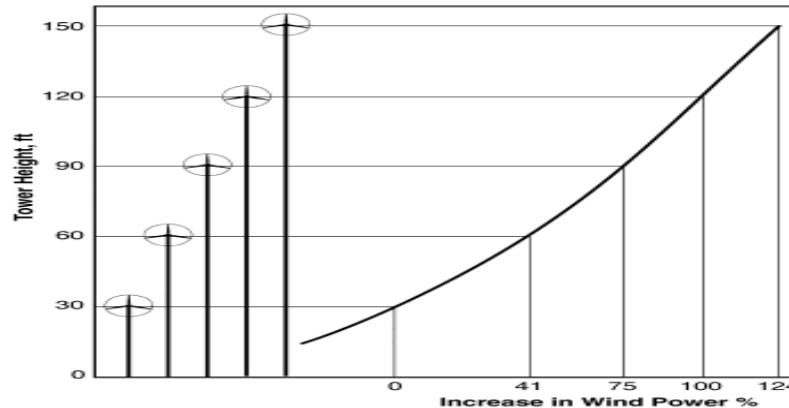

Figure Wind speeds increase with height.

The fundamental equation governing the mechanical power capture of the wind turbine rotor blades, which drives the electrical generator, is given by

$$P_{win}(t) = \frac{1}{2} * \rho * A * V(t)^3 * C_p * Eff_{ad}$$

Where  $\rho$  = air density ( $\text{kg/m}^3$ )

A = area swept of rotor ( $\text{m}^2$ )

V = wind speed (m/s) and Eff<sub>ad</sub> = efficiency of the AC/DC Converter

The theoretical maximum value of the power coefficient  $C_p$  is 0.59 and it is often expressed as function of the rotor tip-speed to wind-speed ratio (TSR). TSR is defined as the linear speed of the rotor to the wind speed.

$$TSR = \omega R / V$$

Where R and  $\omega$  are the turbine radius and the angular speed, respectively. Whatever maximum value is attainable with a given wind turbine, it must be maintained constant at that value for the efficient capture of maximum wind power. Power is directly proportional to wind speed, as the wind speed increases the power delivered by a wind turbine also increases. If wind speed is between the rated wind speed and the furling speed of the wind turbine, the power output will be equal to the rated power of the turbine. Finally, if the wind speed is less than the cut-in speed or greater than the furling speed there will be no output power from the turbine.

Power output from practical turbine:

The fraction of power extracted from the power in the wind by a practical wind turbine is usually given the symbol  $C_p$ , standing for the coefficient of performance. Using this notation and dropping the subscripts of Eq. the actual mechanical power output can be written as

$$P_m = C_p (\frac{1}{2} \rho A u^3) = C_p P_w$$

- MATLAB PROGRAMMING OF WIND TURBINE

(a) The graph for power generated by a wind turbine for single value of  $C_p$  is shown below.



# International Journal of Advanced Research in Electrical, Electronics and Instrumentation Engineering

(ISO 3297: 2007 Certified Organization)

Vol. 2, Issue 8, August 2013

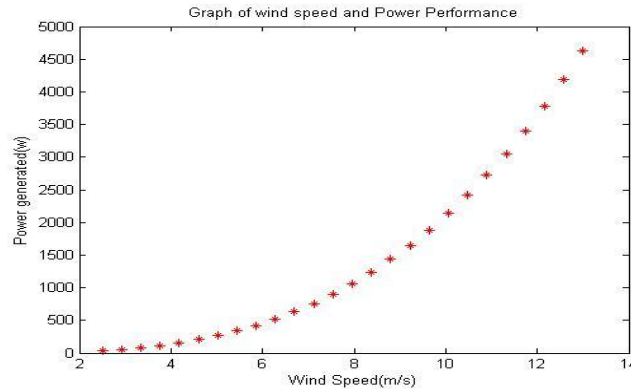

(b) The graph for power generated by a wind turbine for different value of  $C_p$  is shown below.

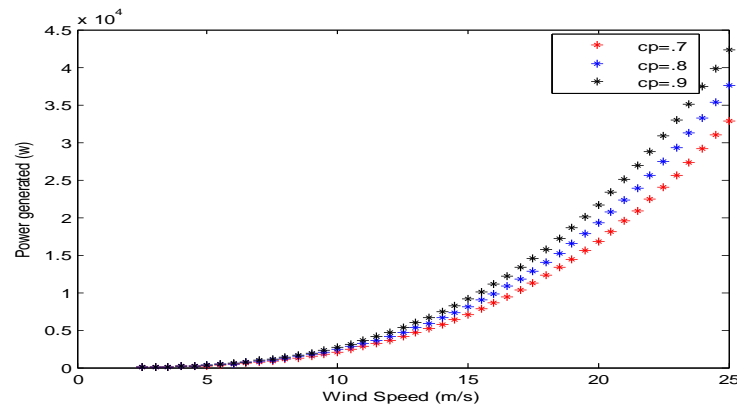

## V. HYBRID MODEL OF PV SOLAR AND WIND ENERGY

The escalation in electrical energy costs associated with fossil and nuclear fuels, and enhanced public awareness of potential environmental impacts of conventional energy systems has created an increased interest in the development and utilization of alternate sources. Photo voltaic and wind energy are being increasingly recognized as cost effective generation sources in small isolated power systems. A realistic cost benefit analysis requires evaluation models that recognize the highly erratic nature of these energy sources while maintaining the chronology and inter dependence of the random variables inherent in them. Currently we can observe very fast development of new electrical power sources called renewable sources. These sources are environmentally friendly and use primary energy carriers like solar, wind and water flow, biogas, biomass etc.

The escalation in costs and environmental concerns involving conventional electric energy sources has increased interest in renewable energy sources. Wind, Solar PV and Biomass power generations are viable options for future power generation. Besides being pollution free, they are free recurring costs. They also offer power supply solutions for remote areas, not accessible by the grid supply. Today, around 30,000 wind turbines and more than 1, 00,000 off-grid Solar PV systems are installed all over the world. Hybrid systems can address limitations in terms of –

1. Fuel Flexibility



## International Journal of Advanced Research in Electrical, Electronics and Instrumentation Engineering

(ISO 3297: 2007 Certified Organization)

**Vol. 2, Issue 8, August 2013**

2. Efficiency
3. Reliability
4. Emissions
5. Economics

- The hybrid system of solar/wind is environmental friendly.
- Uses conventional energy resources.
- Need of the hour to use conventional energy resources.
- Efficient way of supplying electricity.
- Wind speed and sun shine is different in different parts of the world.

As the wind does not blow all the time nor does the sun shine all the time, solar and wind power alone are poor power sources. Hybridizing solar and wind power sources together with storage fuel cell to cover the periods of time without sun or wind provides a realistic form of power generation. Land is a scarce resource in India and per capital land availability is low. Dedication of land area for exclusive installation of solar arrays might have to compete with other necessities that require land. The amount of land required for utility-scale solar power plants—currently approximately 1 km<sup>2</sup> for every 20–60 megawatts (MW) generated could pose a strain on India's available land resource. The architecture more suitable for most of India would be a highly distributed set of individual rooftop power generation systems, all connected via a local grid. However, erecting such an infrastructure, which does not enjoy the economies of scale possible in mass, utility-scale, solar panel deployment, needs the market price of solar technology deployment to substantially decline, so that it attracts the individual and average family size household consumer.

That might be possible in the future, because PV is projected to continue its current cost reductions for the next decades and be able to compete with fossil fuel. Some noted think-tanks recommend that India should adopt a policy of developing solar power as a dominant component of the renewable energy mix, since being a densely populated in the sunny tropical belt, the subcontinent has the ideal combination of both high solar insolation and therefore a big potential consumer base density. In one of the analyzed scenarios, India can make renewable resources such as solar the backbone of its economy by 2050, reining in its long-term carbon emissions without compromising its economic growth potential.

The standalone solar photovoltaic energy system cannot provide reliable power during non-sunny days. The standalone wind system cannot meet the constant load demands due to significant fluctuations in the magnitude of wind speeds throughout the year. Therefore, energy storage systems will be required for each of these systems in order to satisfy the power demands. Usually storage

System is expensive and the size has to be reduced to a minimum possible for the renewable energy system to be cost effective. Hybrid power systems can also be used to reduce energy storage requirements. By integrating and optimizing the solar photovoltaic and wind systems, the reliability of the systems can be improved and the unit cost of power can be minimized. In India the Solar-Wind Hybrid power plants are technically approved by the Ministry of New and Renewable Energy (MNRE). These Solar / Wind Hybrid power plants generate electricity and can be an alternate source for the costly diesel generators which are run during the power cuts and also in locations where continuous EB supply is not available. The Returns on Investment (ROI) of these projects are very less and also with the Central Financial Assistance provided by the governments it is much faster. With these systems we can generate, store and use the power as and when required and also for rural electrification.

The Solar/Wind hybrid model block diagram is shown in the figure below:



# International Journal of Advanced Research in Electrical, Electronics and Instrumentation Engineering

(ISO 3297: 2007 Certified Organization)

Vol. 2, Issue 8, August 2013

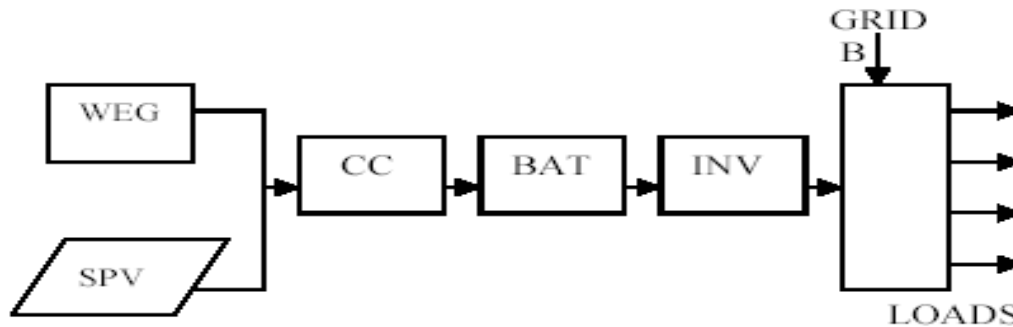

Fig- Wind / SPV Hybrid energy model configuration.

Where,

- WEG = wind energy generator
- SPV = solar photovoltaic panels
- CC = power conditioning units
- BAT = battery banks
- INV = inverter

Combine power output power from a Wind and a PV module:

The total wind- and PV-generated power during each hour is first computed as follows:

$$P_{Gen}(t) = P_{Wind}(t) + N_{PV} \times P_{PV}(t)$$

Where NPV is the number of PV panels, and  $P_{Wind}(t)$  is the power from the wind at time.

- MATLAB PROGRAMMING OF HYBRID MODEL WITH USING BATTERY

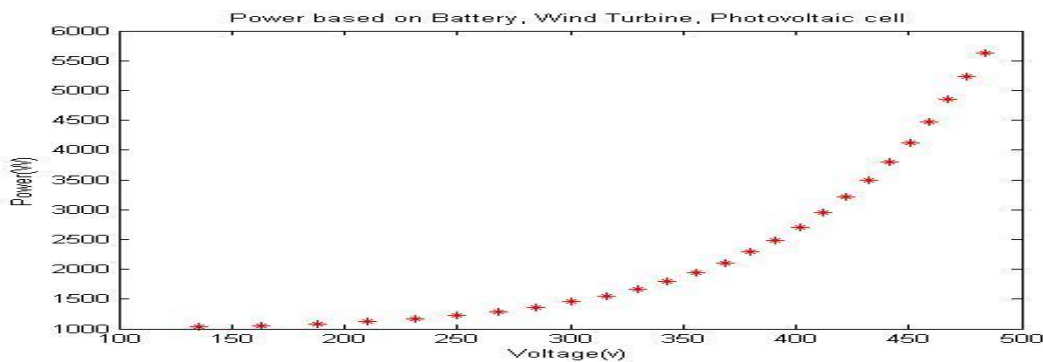

## VI. CONCLUSIONS

Obviously, a complete hybrid power system of this nature may be too expensive and too labor intensive for many Industrial Technology Departments. The enhancements to instruction, especially in making electrical power measurements more physical, intuitive and real-world are substantial and the costs and labor involved in some adaptation of the ideas in this paper to a smaller scale setup are reasonable. In other places, other power sources could be used. For example hybrid combinations of wind power, solar power, geothermal power, hydroelectric power, tidal power, biomass generated power, power from incineration of solid wastes, and many other technologies



# International Journal of Advanced Research in Electrical, Electronics and Instrumentation Engineering

(ISO 3297: 2007 Certified Organization)

**Vol. 2, Issue 8, August 2013**

could be considered depending on local interests and resources. The key element of this test bed concept presented in this paper are two or more renewable power sources connected to a power grid with complex electrical interactions.

## REFERENCES

1. J. Bhagwan Reddey, D.N. Reddy “Probabilistic Performance Assessment of a Roof Top Wind, Solar Photo Voltaic Hybrid Energy System”, Engineering Science and Education Journal, Vol. 2, No. 4, pp. 281-298, February 2008.
2. Stanley R. Bull, “Renewable Energy Today and Tomorrow”, Proceedings of the IEEE, vol. 89, no. 8, pp. 316-381, August 2001.
3. R.Chedid & H. Akiki, “A decision Support Technique for the Design of Hybrid Solar-Wind Power System”, IEEE Transaction of Energy Conversion Vol. 13, No.1,pp. 154-176, March 1998.
4. Nabil A. Ahmed & Masafumi Miyatake, “A Stand-Alone Hybrid Generation System Combining Solar Photovoltaic and Wind Turbine with Simple Maximum power Point Tracking Control”.
5. Riad Chedid & Safur Rahman, “Unit Sizing and Control of Hybrid Wind Solar Power Systems”, IEEE Transaction of Energy Conversion, Vol. 12, No. 1, pp. 181-195, March 1997.
6. Jozef Paska, Piot & Biczel, Mariusz Klos, “Experience with Hybrid Power Generating System”.
7. Rajesh Gopinath, Sangsun Kim, Jae-Hong Hahn, Prasad No. Enjeti, Mark B. Yeary and Jo W. Howze, “Development of a Low Cost Fuel Cell Inverter System with DSP Control”, IEEE Transaction on Power Electronic Vol 19, No. 5 pp.654-854,Sept. 2004.
8. Jin Wang, Fang Z. Peng, Joel Anderson, Alan Joseph and Ryan Buffen Barger, “Low System for Residential Power Generation”. IEEE Transaction on Power Electronics, pp.660-687, Vo. 19, No. 5, Sept2009.
9. J. Bhagwan Reddey, D.N. Reddy “Probabilistic Performance Assessment of a Wind, solar Photo Voltaic Hybrid Energy System”.
10. Dr. Recayi Pecen, Dr. MD Salims, Dr. Marc Timmerman, “ A Hybrid Sola-wind Power Generation System as an Instructional Resource for Industrial Technology Students”, Vol. 16, No. 3, pp. 565-600, May/July 2000.
11. Sunny W. Y. Tam and Tom Chang, , “Kinetic Evolution and Acceleration of the Solar Wind”, Geophysical research letter, Vol. 26, No. 20, pp. 3189- 3192, October 1999.
12. Yvonne Coughlan, Paul Smith, Alan Mullane, Member, IEEE and Mark OMalley, “ Wind Turbine Modelling for Power System Stability Analysis –A system operator Perspective”, IEEE Transaction on Power System, Vol. 23, No. 3, pp. 345-375, August 2007.
13. M.Hassem Nehrir, Brock J.LaMeres, Giri Venkataramanan, Victor, L.A. Alvarado, “An Approach to Evaluate the General Performance of Stand-Alone Wind/PV Generating Systems”, Engineering Science and Education Journal, Vol. 15, No. 4, pp.205-234, December 2000.
14. Book on, “Wind Turbines”.
15. Book on, “Wind and Solar Power system”.