



## International Journal of Advanced Research in Electrical, Electronics and Instrumentation Engineering

(An ISO 3297: 2007 Certified Organization)

Vol. 3, Issue 5, May 2014

# LabVIEW and Web-Server based Human Body Monitoring System

N. P. Joshi<sup>1</sup>, P.V.Patel<sup>2</sup>

Assistant professor, Dept. of ECE, R. K. University, Rajkot, Gujarat, India<sup>1</sup>

PG Student [EC] , Dept. of ECE, R. K. University, Rajkot, Gujarat, India<sup>2</sup>

**ABSTRACT:** This paper indicates the method of monitoring human body parameters like temperature, heartbeat rate, SPO2 using embedded web server and LabVIEW technology. The hardware is developed on Arduino 2560 controller board and Ethernet shield as well as different sensors. LabVIEW is used in software part to provide GUI based environment to user and Ethernet shield is used to generate embedded web server. It can be applied in internet through website or network system so patient's condition and biomedical parameters can be monitor worldwide. It is Low cost and low power system in term of hardware as well as software.

**KEYWORDS:** Arduino, DS1621, Ethernet Shield, GUI, LabVIEW, Pulse oximeter, SPO2, VISA, Webpage, Web Server

### I. INTRODUCTION

This paper consist the basic system for Human body monitoring implementation for a patient in hospitals. Under the critical situation some patients need continuous observation so this type of system really helpful in hospitals or nursing homes.

This basic system include biomedical parameters like temperature, heartbeat rate and SPO2 monitoring implemented system by low cost hardware component as well as GUI platform in computer by LabVIEW. This live embedded human body monitoring system may also be included internet website based transmission support by implementing using Arduino and Ethernet shield as base. This project covers live monitoring system for hospital or nursing home for patients under critical condition and need to be carefully checkup in time and their critical biomedical parameters must be supervised in time. This system support live internet web transmission of patient's body parameters as well as GUI based platform in local hospital computers by LabVIEW interface with different biomedical sensors and hardware part.

### II. PROPOSED METHODOLY

This complete system requires basic hardware and software requirements for continuous monitoring human body biomedical parameters.

For hardware implementation Arduino Mega2560 Development Board, Ethernet shield, Temperature Sensor, SPO2 Sensor, PC with LAN driver installed, Amplifier, Current to Frequency converter etc are require.

For software implementation Windows Operating System, National Instruments LabVIEW software, Web Browser, Arduino Sketch Software etc are requiring.

#### 1. HARDWARE IMPLIMENTATION

For hardware implementation different stages are implemented.

In this system first stage is different sensor like Temperature Sensor, Heart beat sensor and SPO2 sensor. DS1621 sensor is used as a temperature sensor which gives analog values according to current temperature. This analog value is given to Arduino Mega ADC channel for digital conversion. This sensor gives output in Celsius form but we generally measured human body temperature in Fahrenheit. Temperature readings are converted into Fahrenheit

# International Journal of Advanced Research in Electrical, Electronics and Instrumentation Engineering

(An ISO 3297: 2007 Certified Organization)

Vol. 3, Issue 5, May 2014

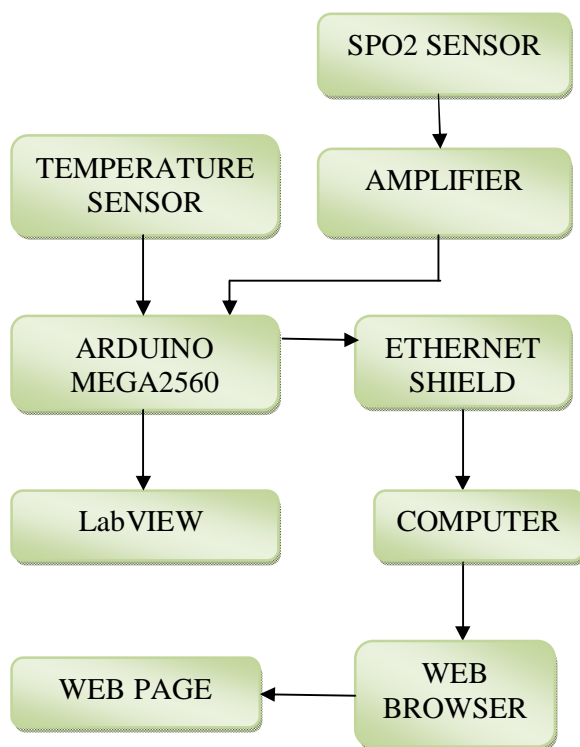

Fig. 1 Architecture of Human Body Temperature Monitoring System

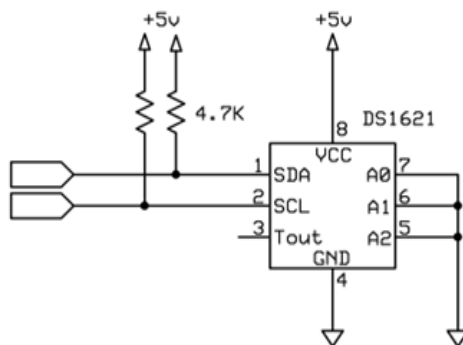

Fig. 2 Temperature Sensor

SPO2 sensor is also called Pulse oximeter. It is used to measure oxygen level in blood as well as heart beat rate of human body. Pulse oximetry has become a standard procedure for the measurement of blood-oxygen saturation in hospitals, clinics, etc. Pulse oximeter can directly detect hypoxemia, deficiency of oxygen saturation in the arterial blood. Early detection of hypoxemia can reduce the gas poisoning by CO<sub>2</sub> or CO, tissue damage, etc. Thus, the oxygen saturation of the blood can quickly and accurately be monitored non-invasively using pulse oximeter.

## International Journal of Advanced Research in Electrical, Electronics and Instrumentation Engineering

(An ISO 3297: 2007 Certified Organization)

Vol. 3, Issue 5, May 2014



Fig 3. Pulse Oximeter Sensor

Pulse oximeter works on the principal of absorption and reflectance/transmittance of light by multiple components like skin, muscle and blood vessel. Absorption due to tissue, skin or muscle remains fairly constant, whereas absorption due to arterial blood varies. Arteries expand due to the pumping of the heart, expanding the arteries and inturn increasing the tissue between the LEDs and the photodiode, thus increasing the light absorption. Using this principle, heart rate can be detected. Absorption of oxyhemoglobin and the deoxygenated hemoglobin form differs significantly with wavelengths (i.e.) oxygen is transported in the blood by hemoglobin, and, depending on the binding of oxygen to the hemoglobin, absorption of light takes place at two wavelengths but this sensor gives very low power output so output signal must be amplify.

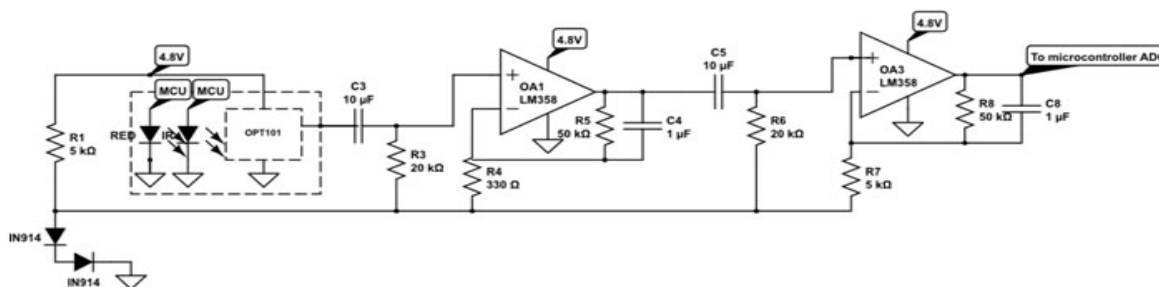

Fig 4. Amplifier for Sensor

This all data are serially transmitted over serial port for LabVIEW GUI display. In LabVIEW screen live biomedical parameters are displayed. To display current temperature readings in the web-page, web-based protocol HTTP is used and website is designed into simple HTML language.

Basically Ethernet Shield is used for interfacing the web-server concept to this project. HTML based website is developed in Arduino programming and transmitted over a LAN or Internet via Ethernet Shield to the PC/Clients.

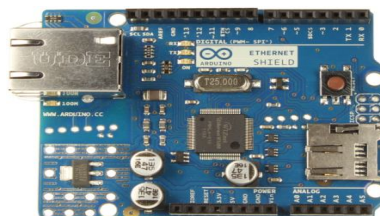

Fig. 5 Ethernet Shield



# International Journal of Advanced Research in Electrical, Electronics and Instrumentation Engineering

(An ISO 3297: 2007 Certified Organization)

Vol. 3, Issue 5, May 2014

## 2. SOFTWARE IMPLIMENTATION

In Arduino sketch Code is written and must require adding below Libraries.

- Wire
- SPI
- Ethernet
- FreqCount
- TimerOne

```
copy | Arduino 1.0.5
File Edit Sketch Tools Help
copy $
/*
Web Server

A simple web server that shows the value of the analog in
using an Arduino Wiznet Ethernet shield.

Circuit:
* Ethernet shield attached to pins 10, 11, 12, 13
* Analog inputs attached to pins A0 through A5 (optional
*/
#include <SPI.h>
#include <Ethernet.h>
#include <Wire.h>
#include <FreqCount.h>
#include <TimerOne.h>

Done compiling.

Binary sketch size: 18,994 bytes (of a 258,048 byte
maximum)
14 Arduino Mega 2560 or Mega ADK on COM7
```

Fig. 6 Arduino sketch Code

DS1621 supports I2C protocol, so it require Wire library for Arduino. Ethernet & SPI libraries are used for Ethernet shield. FreqCount and TimerOne libraries are used for pulse oximeter sensor.

In LabVIEW screen temperature, Heart beat and SPO2 readings are display using different indicators. Temperature reading indicates by thermometer as well as numeric indicator. Same as SPO2 reading is also indicates by numeric display. Heart beat displays in waveform chart.

Serial communication between Arduino and LabVIEW is established by VISA (Virtual Instrument Software Architecture) drivers. First VISA driver must be installed and then VISA controls is used in the block diagram, VISA Open, VISA Read, VISA close etc blocks are used for this purpose.

In LabVIEW front panel and block diagram screens are appear. Programming code is prepare in block diagram and result displays in front panel.

Simple LabVIEW front panel and block diagram is designed which looks like this.



# International Journal of Advanced Research in Electrical, Electronics and Instrumentation Engineering

(An ISO 3297: 2007 Certified Organization)

Vol. 3, Issue 5, May 2014

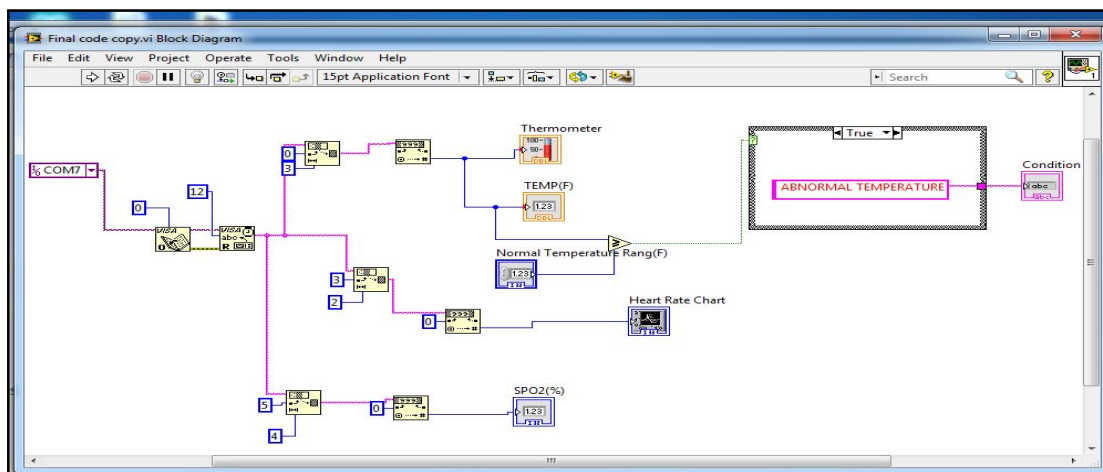

Fig 7 Block Diagram In LabVIEW

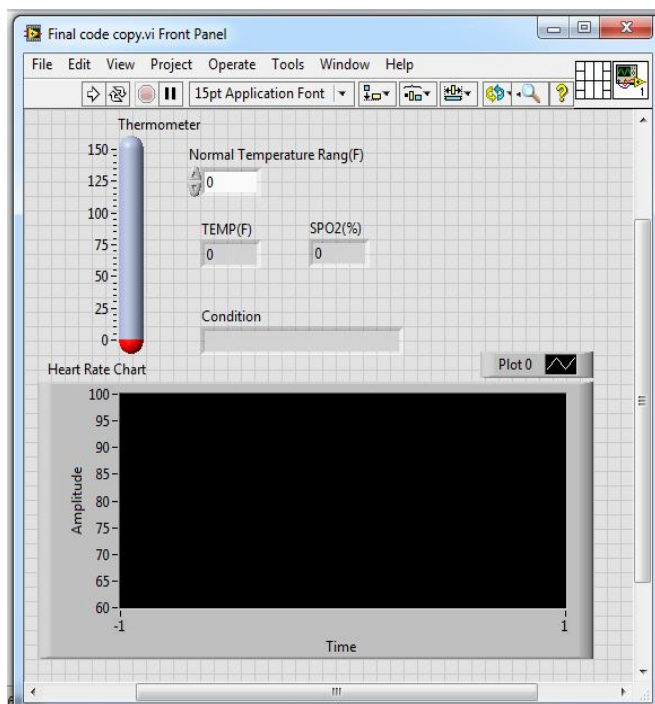

Fig 8 Front Panel in LabVIEW

Web-browser also displays appropriate temperature, heart beat and SPO2 readings from the Arduino through Ethernet shield connected to the PC. IP configuration is required for this purpose,

PC IP Address: 192.168.1.2  
PC Gateway IP: 192.168.1.1



# International Journal of Advanced Research in Electrical, Electronics and Instrumentation Engineering

(An ISO 3297: 2007 Certified Organization)

Vol. 3, Issue 5, May 2014

Arduino Ethernet IP: 192.168.1.1

Ethernet Server is established by Ethernet shield. Internet explorer / Google chrome browser is used to read the biomedical data but proper IP address must require. This webpage is refreshed every particular interval say i.e. 5sec is set, whichever is convenient for monitoring.

### III. RESULTS

After completion of all interfacing of hardware & software programming parts, open the web browser in the PC then type appropriate IP address (192.168.1.1) of the server shield and webpage will be displayed.

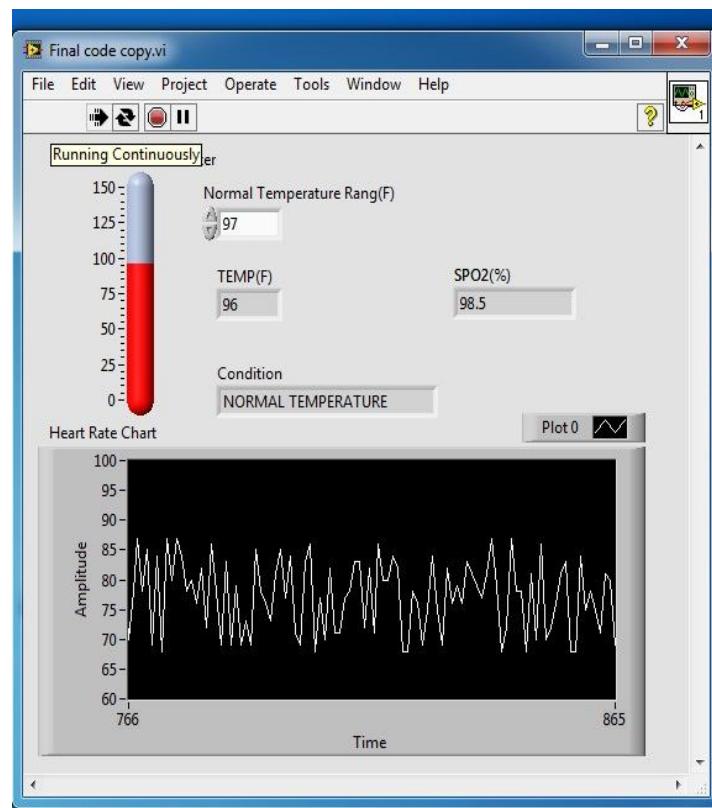

Fig 9 Result in LabVIEW

To get output it must be select appropriate COMPORT and then run the block diagram.  
To get output in web page, it must be require entering appropriate.



# International Journal of Advanced Research in Electrical, Electronics and Instrumentation Engineering

(An ISO 3297: 2007 Certified Organization)

Vol. 3, Issue 5, May 2014

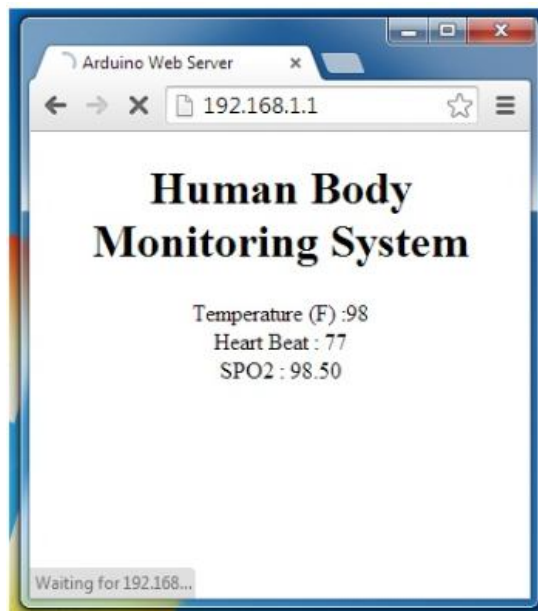

Fig. 10 Result in Webpage

## IV. CONCLUSION

These are many applications related to patient's monitoring system with many available sensors including temperature, oxygen saturation level, heart-beat and more. This system provides continues monitoring of patient as well as it provide GUI based environment to Users. The system designed efficiently and met all expectations as set earlier. In future more biomedical sensors can interface with this system.

## REFERENCES

- [1] Cho Zin Myint, Nader Barsoum, Wong Kiing Ing "Design A Medicine Device For Blood Oxygen Concentration And Heart Beat Rate" Global Journal On Technology & Optimization Vol-1, pp. 66-71, June 2010.
- [2] Haimaprada Sahoo and Kumar Biswal "Patient Monitoring System for Cardiovascular patient with body temperature using Lab VIEW" International Journal of Engineering Research and Development Vol 6, ), PP. 27-30, Issue 8, April 2013.
- [3] Kala Venugopal, aand Amit Kumar "Centralized Heart Rate Monitoring and Automated" International Journal of Scientific and Research Publications, Vol 3pp. 1-4, Issue 9, September 2013.
- [4] Laiali Almazaydeh, Miad Faezipour, Khaled Elleithy "A Neural Network System for Detection of Obstructive Sleep Apnea Through SpO2 Signal Features" International Journal of Advanced Computer Science and Applications, Vol. 3, pp. 7-11, No.5, 2012.
- [5] Mohamed Fezari, Mounir Bousbia-Salah, and Mouldi Bedda "Microcontroller Based Heart Rate Monitor" The International Arab Journal of Information Technology, Vol. 5, pp. 153-157, No. 4, October 2008.
- [6] M. Kassim, M.N. Ismail and C.K.H. Che Ku Yahaya" A Web Based Temperature Monitoring System" International Journal Of Multidisciplinary Sciences And Engineering, Vol. 2, pp. 17-25, No. 1, March 2011.
- [7] Mr. Bhavin Mehta, Ms.Divya Rengarajan, Mr. Ankit Prasad "Real Time Patient Tele-monitoring System Using LabVIEW" International Journal of Scientific & Engineering Research, Vol 3, pp. 1-11 Issue 4, April-2012
- [8] Prabakaran.C.R, Vijayakumar.P, Suryaprakash.R Web "Based Patient Monitoring System Using Arm9 Processor" International Journal of Electrical, Electronics and Data Communication, ISSN: 2320-2084 Vol 1, pp. 49-53, Issue- 7, Sep-2013.
- [9] S. Bagha and L. Shaw "A Real Time Analysis of PPG Signal for Measurement of SpO2 and Pulse Rate" International Journal of Computer Applications , Vol 36, pp. 45-50, No.11, December 2011.
- [10] S. Begum and M Kumarnath.J "LABVIEW Based Module For Bio Signals Monitoring" International Journal of Computer Science and Mobile Computing Vol. 3, pp.423 – 431 Issue. 2, February 2014.
- [11] T.Bheema lingaiah, D.Hanumesh Kumar, C.Nagaraja, Solomon Woldetsadik "Development of Humidity and Temperature Measurement Instrumentation System using LabVIEW" International Journal of Advanced Research in Electrical, Electronics and Instrumentation Engineering Vol. 2, pp. 6365-6372, Issue 10, December 2013.