



ISSN (Print): 2320 – 3765
ISSN (Online): 2278 – 8875

International Journal of Advanced Research in Electrical, Electronics and Instrumentation Engineering

Vol. 6, Issue 11, November 2017

Review on Internet of Things: Recent Applications and its Challenges

P Parhana*, MV Lakshmaiah, S Allaudheen, S Dastagiri, M Vijaya Saritha

Department of Physics, Sri Krishnadevaraya University, Anantapuramu, AP, India

Abstract: Now a day's Internet of things is hot topic and fast growing field. IoT is a sort of “universal global neural network” in the cloud which connects various things. The IoT is intelligently connected devices and systems which comprised of smart machines interacting and communicating with other machines, environments, objects and infrastructures and the Radio Frequency Identification (RFID) and sensor network technologies will rise to meet this new challenge. In each and every organization to send information about the people we use e-mails, website and notice boards but in most of countries internet access is available for transferring information to people via mobile devices and on systems which is easier, fast and less cost through internet. The main aim of this paper gives detailed analysis of Internet of things and various applications in the field of industry, home, retail, medical, agriculture, automotives and transportation, energy and defence and for new related technologies in addition to challenges that facing the development of IoT. This paper helps to researchers who want to do research in the field of Internet of Things.

Keywords: Internet of things; Wireless network; Radio frequency identification; Challenges

I. INTRODUCTION

The term “Internet of Things” (IoT) was first used in 1999 by British technology pioneer Kevin Ashton in the context of supply chain management. As per the definition of Gartner “Internet of Things (IoT) is the network of physical objects that contain embedded technology to communicate and sense or interact with their internal states or the external environment”. The Internet of Things is not just about connecting devices to the internet, but also making sense of the ‘things’ that are connected. The idea of IoT is especially valuable or persons with disabilities, as IoT technologies can support human activities at larger scale like building or society, as the devices can mutually co-operate to act as a total system. IoT is built on the basis of internet, security problems of internet will also show up in IoT [1]. Internet of Things is very quickly becoming a reality. We can see the proof of it around us. Our devices are getting smarter each day from smart phones to smart T.V to smart car to smart kitchen to smart city. Everything is now getting connected to internet. Analyst predicts that there will be 30 billion connected “things” by 2020, while the population of earth will climb to a mere 7.6 billion by 2018, according to UN. The technologies that will aid IoT become reality are RFID and WSN. Radio Frequency Identification (RFID) technology employs 2-way transmitter –receiver to identify and track tags associated with objects. Wireless Sensor Network (WSN) is a wireless network using sensors these networks can monitor the changes happening in physical and environmental conditions. IoT allows the people and things to be connected any time, any place, with anything and any one, ideally using any path/network and any service [2,3] (Figure 1).

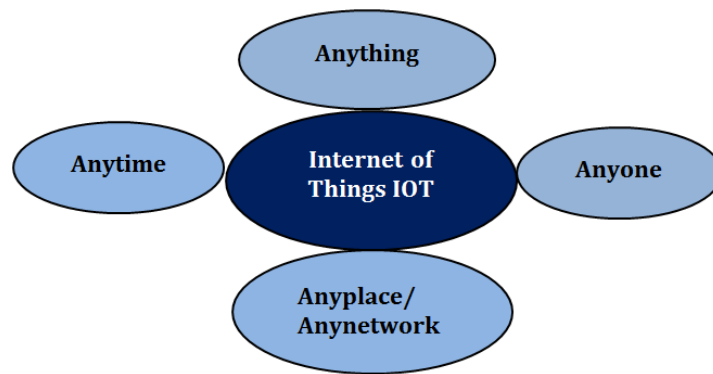

Figure 1: Internet of things.

II. GROWTH OF IOT

The internet first evolved as “internet of computers”. In these days many people started using the internet- “internet of people”. On the other hand technology has been developed day by day and at the same time on era of “mobicomp” (mobile computing) had begun. Today’s 3G and 4G mobile have fast accessing internet and deliver better quality in video calls. Wireless technologies and mobile computing became cheaper compared to early years and have gained more popularity. Hence a new computing had emerged- Ubiquitous computing. This computing focuses on smart, intelligent space and minimal user involvement. Advancement in technology led to mobile and other hand-held devices to diminish in size. Smart phones, Ipads, tablets and notebooks replaced ordinary mobiles and PCs. Hence there was a change in the device with which people access the internet. This in turn resulted in sophisticated features being configured in devices such as sensors, Global Positioning system (GPS) and actuators. In such a scenario devices were not only connected to the internet but also sense, compute and perform intelligent tasks. The International telecommunications Union (ITU) has pointed out four dimensions of IoT: object identification (“tagging things”), sensors and wireless sensor networks (“feeling things”), embedded systems (“thinking things”) and nanotechnology (“shrinking things”) [4,5] (Figure 2).

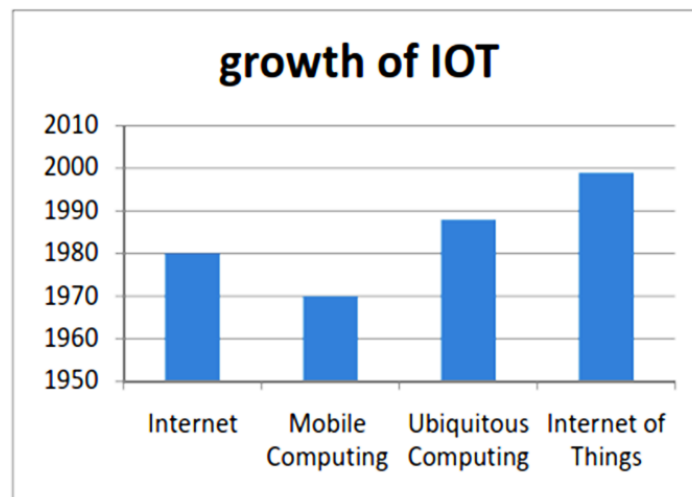

Figure 2: Growth of internet of things.

III. TECHNOLOGIES OF IOT

The main objective of IoT is to make things or objects in the world to be connected through internet, Wireless sensor networks (WSN) and smart phones so that they can share information automatically just like people sharing information. To implement this motive, there are many technologies such as sensing, Radiofrequency identification (RFID), wireless sensor networks (WSN), embedded systems and nano technology helps the things to communicate among them that will aid IoT become reality [6,7].

A. Radio Frequency Identification (RFID)

Radio Frequency Identification (RFID) is a wireless communication technology of transferring data by using electromagnetic fields in order to automatically tracking the location and tags attached to objects, status of objects and remote reading. RFID has been invented by English army during world warII. The main intension of using this, because of low cost and increased capabilities of RFID tags. RFID uses radio frequency waves to transfer identifying information between tagged objects and RFID reader without line of sight and physical contact. It provides two basic quintessential functions for an IoT i.e., identification and communication. RFID system consists of two components they are RFID tags (transponders) and RFID readers (receivers). The RFID tags have a microchip to record information using Electronic Product code (EPC) (or) Universal Identification and an embedded antenna. There are two types of tags: active and passive tags. Active tags have inbuilt battery and permits tags to be read from distance location and transmit data constantly to the reader. Passive tags don't have their own battery and only transmit EPC when transceiver activates them by coming within the range. The working of RFID application is, RFID tags are attached to the items so that host items have to be monitored by system using tag readers. When the passive tag is approached by a reader, they respond with their EPC and passive tags obtain energy from electrical signal transmitted by reader. Using inductive coupling the energy from signal is absorbed by tag which converted it into electrical current and stored in an on-board capacitors that it can respond to reader with an EPC. RFID technology not only contributed towards technical progress but also towards cost reduction and standardization and hence it is widely used (Figure 3).

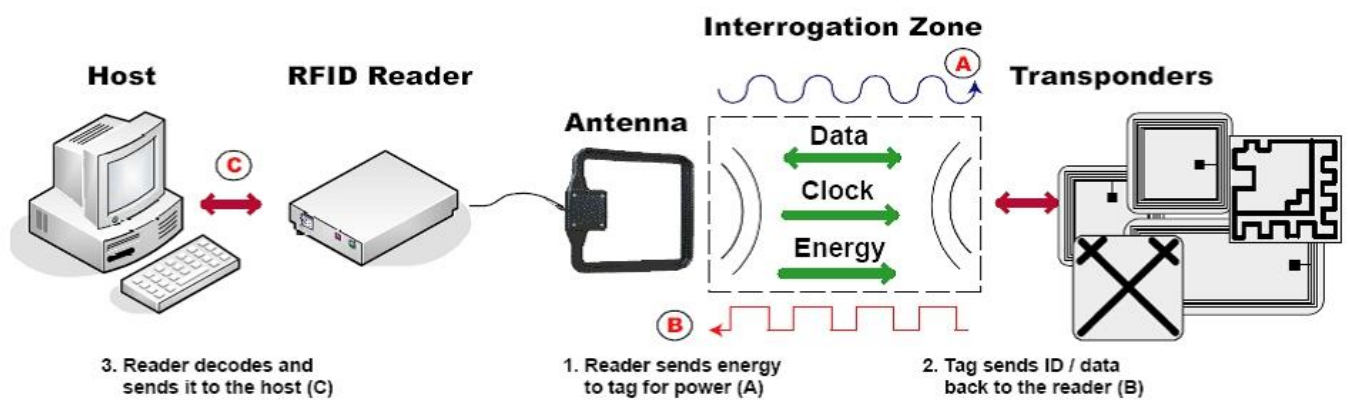
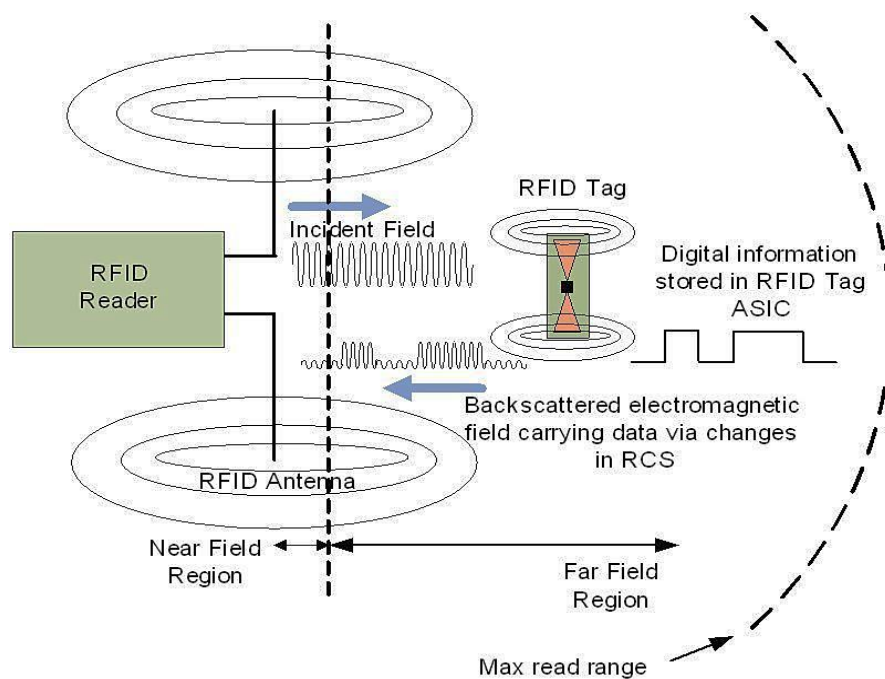

Figure 3: RFID communication system.

RFID is used in food supply chain to insure that the foods are fresh. Consumers can use RFID information to check all nodes of the supply chain, especially in the cool supply chain. That is to say, Goods attached by RFID can be traceable in the supply chain.

B. Wireless Sensor Networks

Wireless sensor networks (WSN) play important role in connecting the physical world to information world. With the advancement of Micro electro mechanical systems (MEMS), wireless communication technology and digital electronics led to the development of tiny devices having the ability to sense, compute and communicate wirelessly over short distance. These tiny devices are called nodes. These nodes interconnect to form wireless sensor networks (WSN). These nodes contain a sensor (collecting data), microcontroller (computing data and controlling the node), memory (storing program and data), radio transceiver (for communication with other nodes) and a battery (power supply). These sensors work together to collect data and send it to the sink node which redirects data to the destination. All these sensors nodes construct a path to sink node on which path there are many nodes. One node communicates with its neighbour node and its neighbour send their signals to their neighbours so that the signals send to sink node by relay. For communication range of sensor nodes in WSN is limited, multiple hops are required in order to transmit data from source to destination.

IV. APPLICATIONS OF IOT

Recently, IoT developer focuses on various real time issues. In various areas, IoT application developed i.e., healthcare, agriculture, smart buildings (school, hospital, home), supply chain management, retail, transportation, industry, infrastructure monitoring and defence etc. [8-16] (Figure 4).

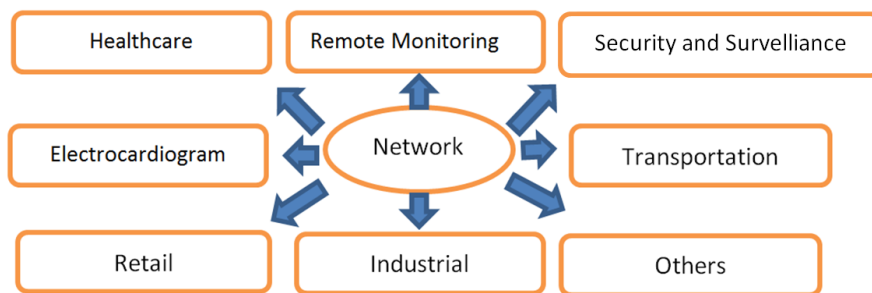

Figure 4: Applications of IoT in various fields.

A. In Healthcare

There are exciting applications of IoT in healthcare that provide enhance the patient experience, improve patient care and save the vast amounts of money. Identification of various drugs is an important application of IoT in healthcare area. IoT unlocks the potential of existing technologies, and leads us toward new and better medical device solutions. IoT devices not only improve facilities and professional practice, but also health in the daily lives. Most studies reviewed point to a chronic disease monitoring in particular as in which are responsible for the first remote monitoring of vital signs and the second of a telemedical Electrocardiogram (ECG) system of a patient.

B. Remote Monitoring

With the lack of health monitoring systems may leads to many health risks go undetected and patient undergoes many problems. This is the major problem facing all over the world. For checking the vital signs data to be healthy or unhealthy, we need a nurse or doctor advice and again cost is increased. This may be risk for the elder people to overcome this issue, a small and powerful wireless solutions connected via IoT for monitoring to come to patients instead of vice versa. Using these wireless solutions patients' health data can be captured. A variety of sensors and their related algorithms are used to analyze the heath data and send it through wireless connectivity and then medical professionals can take the data then make the appropriate health recommendations remotely. Many e-Health systems developed and they are providing remote monitoring of patient and these monitoring systems are low cost and they are continuously monitoring the patient's health condition and accurately measuring the patient's psychological parameters such as body temperature, blood pressure, pulse rate and respiration rate of patient (Figure 5).

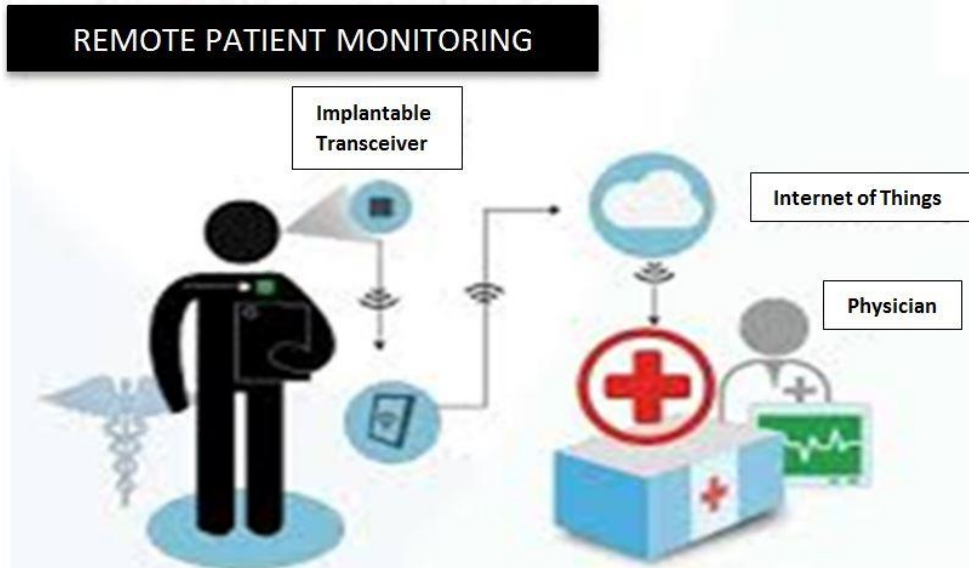

Figure 5: Remote patient monitoring.

C. Electrocardiogram Monitoring (ECG)

The application of IoT to ECG monitoring has the potential to give maximum information and can be used to its fullest extent. An ECG is machine that connected to internet to facilitate the exchange of information is required. The monitoring of Electrocardiogram (ECG) that is electrical activity of heart pulse recorded by Electrocardiography includes the measurement of simple heart rate and determination of the basic rhythm as well as the diagnosis of multifaceted arrhythmias, myocardial ischemia and prolonged QT intervals.

D. In Agriculture

India is agriculture oriented country. 69% of Indian population has agriculture as their main occupation. The advancement in the IoT technology will help farmers increase the crop gain. As Iot application in agriculture continues to develop, farms will become more connected more streamlined, more efficient and ultimately more productive. Internet of Things will effectively solve the quality and safety problems of agricultural Products. The important applications of IoT in agriculture are water quality monitoring, monitor soil constituent, water irrigation and pest monitoring (Figure 6).

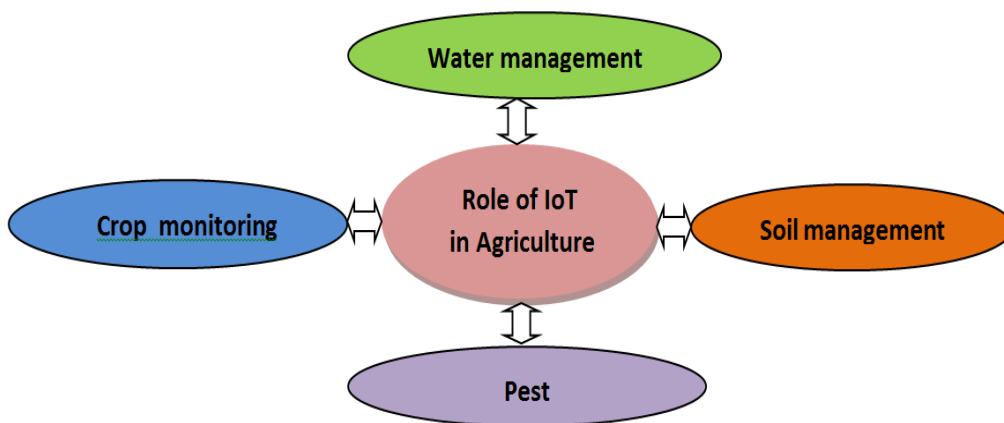

Figure 6: Application of IoT in agriculture.

E. Logistics coordination: This is the best application of IoT in agriculture. Through GPS, RFID and other location-based sensors, goods such as vegetables can be tracked and monitored visually during transportation and storage. This can also facilitate scheduling and add further automation in supply chain management.

E. In Industry

Smart parking space that waits for you. Imagine the time spent and frustration finding a free parking spot-all can be solved with smart parking.

F. Smart Ink

Several manufactures have developed forms of ink that enable electronic circuits to be printed on just about anything. This will enable consumers of print ads to interact with those ads-giving marketing information systems feedbacks, transporting consumers to website, and enabling them to request more information or even order products.

G. Smart Sports

Smart basketball, golf ball, tennis ball, smart rackets, smart bats, smart sneakers and so on as a connected object that can be recognized once it is in a specific space.

H. Smart Clothing

Sensors built in to the fabric, or printed on, clothing will give health and performance feedback to medical personnel and athletes. Markets will use such clothing to monitor physiologic responses to marketing content, product and brand variations and pricing change. Imagine if smart clothing is context-aware whereby you can even change colour and transparency of clothes based on own heart beat and temperature as well as heart beat and temperature of others nearby.

V. CHALLENGES

Though IoT delivers an impressive set of benefits, it also presents a significant set of challenges. The IoT promises to bring the connectivity to an earthly level, every home, vehicle, and workplace with smart, internet-connected devices. Some of major challenges are:

- a. Privacy:** Many IoT applications access personal data but the privacy and protection of personal data may be the one of the major challenge for IoT developers.
- b. Security:** IoT creates an ecosystem of constantly connected devices communicating over networks. The system offers little control despite any security measures. This leaves users exposed to various kinds of attackers. Increasing the number of different devices that increases security issues.
- c. Connectivity:** Variety of wired and wireless connectivity standards are required to enable different application needs.
- d. Scalability:** Size of the systems tends to large in size, the solutions should be scalable. Also any times the deployments happen in stages and the architecture should be able to scale up incrementally without taking too much overhead.
- e. Flexibility:** Many are concerned about the flexibility of an IoT system to integrate easily with another. They worry about finding themselves with several conflicting or locked systems.
- f. Complexity:** The IoT is diverse and complex network. Any failure or bugs in the software or hardware will have serious consequences. Even power failure can cause a lot of inconvenience.
- g. Wireless communications:** When we come to energy point, wireless technologies such as GSM, UMTS, Wi-Fi and Bluetooth are far less suitable. Many recent WPAN trends as ZigBee and other still under development they have narrow band width and consume less energy.

VI. CONCLUSION

Internet of things is a new internet application which leads to an era of smart technology where there exists thing-thing communication rather than human-human communication. With the IoT each and every object in this world can easily tracked and identified and can take decision independently. Networks and technologies are used in building concepts of Internet of Things such as Radio frequency Identification (RFID), Wireless sensor Networks (WSN) play an important role in IoT applications. IoT is used in healthcare, industry, agriculture, transportation, security, utilities, education and other areas, while providing a new ecosystem for application development. There are many privacy and security issues that need to be addressed. If these issues are addressed, then Internet of Things will definitely be global mantra.

VII. REFERENCES

- [1] Natarajan K; Prasath B; Kokila P; Smart Health Care System Using Internet of Things. Journal of Network Communications and Emerging Technologies (JNCET) 2016; 6.
- [2] Giusto D; Iera A; Morabito G; Atzori L; The Internet of Things. 2010.

- [3] Louis C; Johan E; The Internet of Things – Promise for the Future? An Introduction. IST-Africa Conference Proceedings Paul Cunningham and Miriam. 2011.
- [4] Hailay D; Roine R; Systematic review of evidence for the benefits of telemedicine. J Telemed Telecare 2002; 8: 1–7.
- [5] Aminian M; Naji HR; A Hospital Healthcare Monitoring System Using Wireless Sensor Networks. J Health Med Inform 2003; 4: 121.
- [6] Prashant P; Rohan W; Utkatsha K; Vaidehi G; Patient Health Monitoring System using IOT. IRJET 2017; 4: 541.
- [7] Zhao JC; Zhang JF; Feng Y; Guo JX; The Study and Application of the IOT Technology in Agriculture. 3rd IEEE International Conference on Computer Science and Information Technology (ICCSIT) 2010; 2: 9-11.
- [8] Daniele M; Sabrina S; Francesco De P; Imrich C; Internet of things: Vision; applications and research challenges. 2012; 10: 497–1516.
- [9] Vandana S; Ravi T; A review paper on “IOT” & It’s Smart Applications. IJSETR 2016; 5:2016
- [10] Matthew G; Simon K; Internet of Things: Services and Applications Categorization. Advances in Internet of Things 2011; 1: 27-31.
- [11]. Ala Al F; Mohsen G; Mohammed A; Moussa A; Internet of Things: A Survey on Enabling Technologies; Protocols; and Applications IEEE Communication Surveys & Tutorials. 2015; 17: 4.
- [12] R Want; An introduction to RFID technology. IEEE Pervasive Computing; Vol.5; no.1; pp. 25-33; 2006.
- [13] Nath B; Reynolds F; Want R; RFID technology and applications. IEEE Pervasive Computing 2006; 5: 22-24.
- [14] Guicheng S; Bingwu L; The visions; technologies; applications and security issues of Internet of Things. 2011.
- [15] Rupali AM; Komal RH; Rutuja AG; Pranita PD; Yugandhara AT; et al. Internet of Things: Recent Applications and Challenges. IJESC 2017; 7.
- [16] Deeksha J; Venkata Krishna P; Saritha V; A Study on Internet of Things based Applications. 2012.